



The Global Language of Business

Healthcare

Applying GS1 Standards for DSCSA and Traceability

Addendum: Guidance and XML Examples for Supply Chain Choreographies in Lot-Level Management

Release 1.2, Nov 08 2016



Table of Contents

1	Introduction	5
1.1	Diagram Legend.....	5
1.2	The GS1 US DSCSA Implementation Suite.....	5
2	Direct Purchase Scenario – Example 1.....	6
2.1	Sample XML: M → W1	7
2.2	Sample XML: W1 → D.....	9
3	Direct Purchase Scenario – Example 2.....	12
3.1	Sample XML: M → W1, April 1	13
3.2	Sample XML: M → W1, April 3	15
3.3	Sample XML: W1 → D.....	17
4	Direct Purchase Scenario – Example 3.....	21
4.1	Sample XML: M → W1, April 1	22
4.2	Sample XML: M → W1, April 3	24
4.3	Sample XML: W1 → D.....	26
5	Direct Purchase Scenario– Example 4.....	30
5.1	Sample XML: M → W1, April 1	31
5.2	Sample XML: M → W1, April 3	33
5.3	Sample XML: W1 → D.....	35
6	Extended Supply Chain Scenario – Example 1.....	39
6.1	Sample XML: W1 → W2	40
6.2	Sample XML: W2 → D.....	42
7	Extended Supply Chain Scenario – Example 2.....	46
7.1	Sample XML: W1 → W2, April 1	47
7.2	Sample XML: W1 → W2, April 3	49
7.3	Sample XML: W2 → D.....	52
8	Extended Supply Chain Scenario – Example 3.....	56
8.1	Sample XML: W1 → W2, April 1	57
8.2	Sample XML: W1 → W2, April 3	60
8.3	Sample XML: W2 → D.....	63
9	Extended Supply Chain Scenario – Example 4.....	67
9.1	Sample XML: W1 → W2, April 1	68
9.2	Sample XML: W1 → W2, April 3	71
9.3	Sample XML: W2 → D.....	74

10	Contract Manufacturing Scenario – Example 1	78
10.1	Sample XML: M → W1	79
10.2	Sample XML: W1 → D	81
11	Co-License Partner (CLP) Scenario – Example 1	85
11.1	Sample XML: CLP as the Designated DSCSA Transaction Owner, CLP → W1	86
11.2	Sample XML: CLP as the Designated DSCSA Transaction Owner, W1 → D	88
11.3	Sample XML: Manufacturer as the Designated DSCSA Transaction Owner, M → W1	91
11.4	Sample XML: Manufacturer as the Designated DSCSA Transaction Owner, W1 → D	93
12	Contract Packaging Scenario – Example 1	97
12.1	Sample XML: M → W1	98
12.2	Sample XML: W1 → D	100
13	Repackaging Scenario – Example 1	104
13.1	Sample XML: M → R	105
13.2	Sample XML: R → W1	107
13.3	Sample XML: W1 → D	109
14	Repackaging Scenario – Example 2	112
14.1	Sample XML: M → W1	113
14.2	Sample XML: W1 → D	115
15	Repackaging Scenario – Example 3	118
15.1	Sample XML: M → W1	119
15.2	Sample XML: W1 → D	121
16	Repackaging Scenario – Example 4	124
16.1	Sample XML: M → W1	125
16.2	Sample XML: W1 → R/W2	127
16.3	Sample XML: R/W2 → D	130
17	340B Contract Pharmacy Scenario – Example 1	135
17.1	Sample XML: M → W1	136
17.2	Sample XML: W1 → D	138
18	Third Party Logistics Scenario – Example 1	142
18.1	Sample XML: M → W1	143
18.2	Sample XML: W1 → D	145

About GS1

GS1® is a neutral, not-for-profit, global organization that develops and maintains the most widely-used supply chain standards system in the world. GS1 Standards improve the efficiency, safety, and visibility of supply chains across multiple sectors. With local Member Organizations in over 110 countries, GS1 engages with communities of trading partners, industry organizations, governments, and technology providers to understand and respond to their business needs through the adoption and implementation of global standards. GS1 is driven by over a million user companies, which execute more than six billion transactions daily in 150 countries using GS1 Standards.

About GS1 US

GS1 US®, a member of GS1 global, is a not-for-profit information standards organization that facilitates industry collaboration to improve supply chain visibility and efficiency through the use of GS1 Standards, the most widely-used supply chain standards system in the world. Nearly 300,000 businesses in 25 industries rely on GS1 US for trading-partner collaboration that optimizes their supply chains, drives cost performance and revenue growth while also enabling regulatory compliance. They achieve these benefits through solutions based on GS1 global unique numbering and identification systems, barcodes, Electronic Product Code-based RFID, data synchronization, and electronic information exchange. GS1 US also manages the United Nations Standard Products and Services Code® (UNSPSC®).

About GS1 Healthcare

GS1 Healthcare is a global, voluntary healthcare user group developing global standards for the healthcare supply chain and advancing global harmonization. GS1 Healthcare consists of participants from all stakeholders of the healthcare supply chain: manufacturers, wholesalers, and distributors, as well as hospitals and pharmacy retailers. GS1 Healthcare also maintains close contacts with regulatory agencies and trade organizations worldwide. GS1 Healthcare drives the development of GS1 Standards and solutions to meet the needs of the global healthcare industry, and promotes the effective utilization and implementation of global standards in the healthcare industry through local support initiatives like GS1 Healthcare US® in the United States.

About GS1 Healthcare US

GS1 Healthcare US® is an industry group that focuses on driving the adoption and implementation of GS1 Standards in the healthcare industry in the United States to improve patient safety and supply chain efficiency. GS1 Healthcare US brings together members from all segments of the healthcare industry to address the supply chain issues that most impact healthcare in the United States. Facilitated by GS1 US, GS1 Healthcare US is one of over 30 local GS1 Healthcare user groups around the world that supports the adoption and implementation of global standards developed by GS1.

1 Introduction

DSCSA provides that certain distributors can redact certain data elements from the Transaction History in certain situations. This document illustrates how to handle the redaction of Transaction History data elements from EPCIS events. To do that, this document presents diagrams of various example supply chain choreographies in which data elements are redacted from the Transaction History, along with a sample XML illustrating how the redaction can be handled in the EPCIS data. Other example supply chain choreographies in which redaction does not take place are also illustrated for comparison.

! **Important:** Each company is individually responsible for meeting all statutory and/or regulatory requirements for their company and their products. Consult with your company’s legal counsel or compliance team (regulatory or quality) for more specific information about current statutory and regulatory requirements applicable to your company and products.

1.1 Diagram Legend

In the diagrams of each example supply chain choreography:

- “TS” stands for Transaction Statement,
- “TI” stands for Transaction Information,
- “TH” stands for Transaction History, and
- the redaction of Transaction History data is represented by crossing out the data as the next transaction occurs.

In addition, the fictitious parties used in the diagrams and XML examples presented in this document are defined in the table below.

Table 1-1 Key to Parties in Diagrams

Party	Role	Name	GLN
M	Manufacturer	GS1 Pharma LLC	0300000000001
W1	Wholesaler (purchasing directly from manufacturer)	GS1 Drug Distro LLC	0614141000005
W2	Wholesaler (purchasing from W1)	GS1 Cayman Islands Wholesale	9508888000002
D	Dispenser	GS1 <i>Pere et Fils</i> Pharmacy	5012345000008

1.2 The GS1 US DSCSA Implementation Suite

To promote ease of use, the content for applying GS1 Standards to DSCSA and traceability has been split into four documents. All of these documents are available in the [GS1 US DSCSA Implementation Suite](#). The four documents in that suite are:

- *Implementation Guideline: Applying GS1 Standards for DSCSA and Traceability*
- *Addendum: Guidance and XML Examples for Supply Chain Choreographies in Lot-Level Management*
- *Addendum: Diagrams and XML Examples for Lot-Level Management Exceptions Processing*
- *Addendum: Diagrams and XML Examples for Serialized Exceptions Processing*

✓ Note: As with all GS1 Standards and solutions, this guide is voluntary, not mandatory. It should be noted that use of the words “must” and “require” throughout this document relate exclusively to technical recommendations for the proper application of the standards to support the integrity of your implementation.

2 Direct Purchase Scenario – Example 1

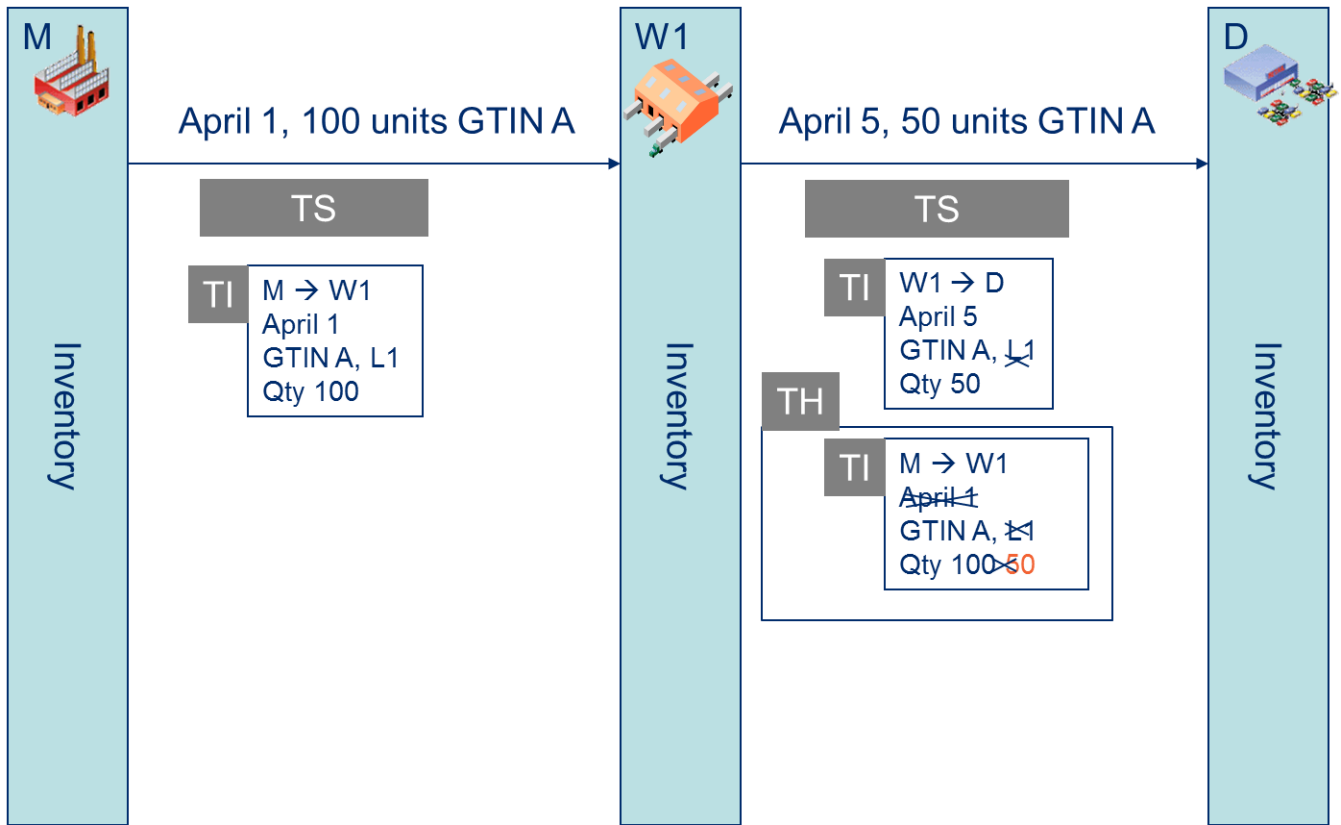

2.1 Sample XML: M → W1

Reference File: <https://resources.gs1us.org/Portals/0/xml/LotChoreo-DirectPurchaseExample1-MtoW1.xml>

```
<?xml version="1.0" encoding="UTF-8" standalone="yes"?>
<!-- Lot Choreography End to End Examples: Direct Purchase Example1: M->W1 -->
<epcis:EPCISDocument xmlns:cbvmda="urn:epcglobal:cbv:mda"
xmlns:sbdh="http://www.unece.org/cefact/namespaces/StandardBusinessDocumentHeader"
xmlns:gslushc="http://epcis.gs1us.org/hc/ns" xmlns:epcis="urn:epcglobal:epcis:xsd:1"
schemaVersion="1.2" xsi:schemaLocation="urn:epcglobal:epcis:xsd:1 EPCglobal-epcis-1_2.xsd"
xmlns:xsi="http://www.w3.org/2001/XMLSchema-instance" creationDate="2014-05-30T15:14:27.574-
04:00">
  <EPCISHeader>
    <sbdh:StandardBusinessDocumentHeader>
      <sbdh:HeaderVersion>1.0</sbdh:HeaderVersion>
      <sbdh:Sender>
        <sbdh:Identifier
Authority="SGLN">urn:epc:id:sgln:030000.000000.0</sbdh:Identifier>
      </sbdh:Sender>
      <sbdh:Receiver>
        <sbdh:Identifier
Authority="SGLN">urn:epc:id:sgln:0614141.000000.0</sbdh:Identifier>
      </sbdh:Receiver>
      <sbdh:DocumentIdentification>
        <sbdh:Standard>EPCglobal</sbdh:Standard>
        <sbdh:TypeVersion>1.0</sbdh:TypeVersion>
        <sbdh:InstanceIdentifier>1234567890</sbdh:InstanceIdentifier>
        <sbdh:Type>Events</sbdh:Type>
        <sbdh:CreationDateAndTime>2014-05-30T15:14:27.574-04:00</sbdh:CreationDateAndTime>
      </sbdh:DocumentIdentification>
    </sbdh:StandardBusinessDocumentHeader>
    <extension>
      <EPCISMasterData>
        <VocabularyList>
          <Vocabulary type="urn:epcglobal:epcis:vtype:EPCClass">
            <VocabularyElementList>
              <VocabularyElement id="urn:epc:class:lgtn:030000.0000001.L1">
                <attribute id="urn:epcglobal:cbv:mda#itemExpirationDate">2015-10-
31</attribute>
              </VocabularyElement>
              <VocabularyElement id="urn:epc:idpat:sgtin:030000.0000001.*">
                <attribute
id="urn:epcglobal:cbv:mda#additionalTradeItemIdentification">00000000001</attribute>
                <attribute
id="urn:epcglobal:cbv:mda#additionalTradeItemIdentificationTypeCode">FDA_NDC_11</attribute>
                <attribute
id="urn:epcglobal:cbv:mda#regulatedProductName">Epcistra</attribute>
                <attribute
id="urn:epcglobal:cbv:mda#manufacturerOfTradeItemPartyName">GS1 Pharma LLC</attribute>
                <attribute id="urn:epcglobal:cbv:mda#dosageFormType">PILL</attribute>
                <attribute
id="urn:epcglobal:cbv:mda#strengthDescription">100mg</attribute>
                <attribute id="urn:epcglobal:cbv:mda#netContentDescription">500
pills</attribute>
              </VocabularyElement>
            </VocabularyElementList>
          </Vocabulary>
          <Vocabulary type="urn:epcglobal:epcis:vtype:Location">
            <VocabularyElementList>
              <VocabularyElement id="urn:epc:id:sgln:030000.000000.0">
```

```

        <attribute id="urn:epcglobal:cbv:mda#name">GS1 Pharma LLC</attribute>
        <attribute id="urn:epcglobal:cbv:mda#streetAddressOne">1295 S George
Ave</attribute>
        <attribute id="urn:epcglobal:cbv:mda#streetAddressTwo">Room
378</attribute>
        <attribute id="urn:epcglobal:cbv:mda#city">Washington</attribute>
        <attribute id="urn:epcglobal:cbv:mda#state">DC</attribute>
        <attribute id="urn:epcglobal:cbv:mda#postalCode">12345-
6789</attribute>
        <attribute id="urn:epcglobal:cbv:mda#countryCode">US</attribute>
    </VocabularyElement>
    <VocabularyElement id="urn:epc:id:sgln:0614141.00000.0">
        <attribute id="urn:epcglobal:cbv:mda#name">GS1 Drug Distro
LLC</attribute>
        <attribute id="urn:epcglobal:cbv:mda#streetAddressOne">230 Park Ave
S</attribute>
        <attribute id="urn:epcglobal:cbv:mda#city">New York</attribute>
        <attribute id="urn:epcglobal:cbv:mda#state">NY</attribute>
        <attribute id="urn:epcglobal:cbv:mda#postalCode">10003-
1502</attribute>
        <attribute id="urn:epcglobal:cbv:mda#countryCode">US</attribute>
    </VocabularyElement>
</VocabularyElementList>
</Vocabulary>
</VocabularyList>
</EPCISMasterData>
</extension>
<gslushc:dscsaTransactionStatement>
    <gslushc:affirmTransactionStatement>true</gslushc:affirmTransactionStatement>
    <gslushc:legalNotice>Seller has complied with each applicable subsection of FDCA Sec.
581 (27) (A) - (G).</gslushc:legalNotice>
</gslushc:dscsaTransactionStatement>
</EPCISHeader>
<EPCISBody>
    <EventList>
        <!-- Transaction Information (TI) -->
        <ObjectEvent>
            <eventTime>2014-04-01T10:11:12Z</eventTime>
            <eventTimeZoneOffset>-05:00</eventTimeZoneOffset>
            <epcList/>
            <action>OBSERVE</action>
            <bizStep>urn:epcglobal:cbv:bizstep:shipping</bizStep>
            <disposition>urn:epcglobal:cbv:disp:in_transit</disposition>
            <readPoint>
                <id>urn:epc:id:sgln:030000.000000.0</id>
            </readPoint>
            <extension>
                <quantityList>
                    <quantityElement>
                        <epcClass>urn:epc:class:lgtn:030000.0000001.L1</epcClass>
                        <quantity>100</quantity>
                    </quantityElement>
                </quantityList>
                <sourceList>
                    <source
type="urn:epcglobal:cbv:sdt:owning_party">urn:epc:id:sgln:030000.000000.0</source>
                </sourceList>
                <destinationList>
                    <destination
type="urn:epcglobal:cbv:sdt:owning_party">urn:epc:id:sgln:0614141.00000.0</destination>
                </destinationList>
            </extension>
        </ObjectEvent>
    </EventList>

```



```

        </extension>
      </ObjectEvent>
    </EventList>
  </EPCISBody>
</epcis:EPCISDocument>

```

2.2 Sample XML: W1 → D

Reference File: <https://resources.gs1us.org/Portals/0/xml/LotChoreo-DirectPurchaseExample1-W1-D.xml>

```

<?xml version="1.0" encoding="UTF-8" standalone="yes"?>
<!-- Lot Choreography End to End Examples: Direct Purchase Example1: W1->D -->
<epcis:EPCISDocument xmlns:cbvmda="urn:epcglobal:cbv:mda"
xmlns:sbdh="http://www.unece.org/cefact/namespaces/StandardBusinessDocumentHeader"
xmlns:gslushc="http://epcis.gs1us.org/hc/ns" xmlns:epcis="urn:epcglobal:epcis:xsd:1"
schemaVersion="1.2" xsi:schemaLocation="urn:epcglobal:epcis:xsd:1 EPCglobal-epcis-1_2.xsd"
xmlns:xsi="http://www.w3.org/2001/XMLSchema-instance" creationDate="2014-05-30T15:14:27.574-
04:00">
  <EPCISHeader>
    <sbdh:StandardBusinessDocumentHeader>
      <sbdh:HeaderVersion>1.0</sbdh:HeaderVersion>
      <sbdh:Sender>
        <sbdh:Identifier
Authority="SGLN">urn:epc:id:sgln:0614141.00000.0</sbdh:Identifier>
        </sbdh:Sender>
      <sbdh:Receiver>
        <sbdh:Identifier
Authority="SGLN">urn:epc:id:sgln:5012345.00000.0</sbdh:Identifier>
        </sbdh:Receiver>
      <sbdh:DocumentIdentification>
        <sbdh:Standard>EPCglobal</sbdh:Standard>
        <sbdh:TypeVersion>1.0</sbdh:TypeVersion>
        <sbdh:InstanceIdentifier>1234567890</sbdh:InstanceIdentifier>
        <sbdh:Type>Events</sbdh:Type>
        <sbdh:CreationDateAndTime>2014-05-30T15:14:27.574-04:00</sbdh:CreationDateAndTime>
      </sbdh:DocumentIdentification>
    </sbdh:StandardBusinessDocumentHeader>
    <extension>
      <EPCISMasterData>
        <VocabularyList>
          <Vocabulary type="urn:epcglobal:epcis:vtype:EPCClass">
            <VocabularyElementList>
              <VocabularyElement id="urn:epc:idpat:sgtin:030000.0000001.*">
                <attribute
id="urn:epcglobal:cbv:mda#additionalTradeItemIdentification">00000000001</attribute>
                <attribute
id="urn:epcglobal:cbv:mda#additionalTradeItemIdentificationTypeCode">FDA_NDC_11</attribute>
                <attribute
id="urn:epcglobal:cbv:mda#regulatedProductName">Epcistra</attribute>
                <attribute
id="urn:epcglobal:cbv:mda#manufacturerOfTradeItemPartyName">GS1 Pharma LLC</attribute>
                <attribute id="urn:epcglobal:cbv:mda#dosageFormType">PILL</attribute>
                <attribute
id="urn:epcglobal:cbv:mda#strengthDescription">100mg</attribute>
                <attribute id="urn:epcglobal:cbv:mda#netContentDescription">500
pills</attribute>
              </VocabularyElement>
            </VocabularyElementList>
          </Vocabulary>

```

```

    <Vocabulary type="urn:epcglobal:epcis:vtype:Location">
      <VocabularyElementList>
        <VocabularyElement id="urn:epc:id:sgln:030000.000000.0">
          <attribute id="urn:epcglobal:cbv:mda#name">GS1 Pharma LLC</attribute>
          <attribute id="urn:epcglobal:cbv:mda#streetAddressOne">1295 S George
Ave</attribute>
          <attribute id="urn:epcglobal:cbv:mda#streetAddressTwo">Room
378</attribute>
          <attribute id="urn:epcglobal:cbv:mda#city">Washington</attribute>
          <attribute id="urn:epcglobal:cbv:mda#state">DC</attribute>
          <attribute id="urn:epcglobal:cbv:mda#postalCode">12345-
6789</attribute>
          <attribute id="urn:epcglobal:cbv:mda#countryCode">US</attribute>
        </VocabularyElement>
        <VocabularyElement id="urn:epc:id:sgln:0614141.00000.0">
          <attribute id="urn:epcglobal:cbv:mda#name">GS1 Drug Distro
LLC</attribute>
          <attribute id="urn:epcglobal:cbv:mda#streetAddressOne">230 Park Ave
S</attribute>
          <attribute id="urn:epcglobal:cbv:mda#city">New York</attribute>
          <attribute id="urn:epcglobal:cbv:mda#state">NY</attribute>
          <attribute id="urn:epcglobal:cbv:mda#postalCode">10003-
1502</attribute>
          <attribute id="urn:epcglobal:cbv:mda#countryCode">US</attribute>
        </VocabularyElement>
        <VocabularyElement id="urn:epc:id:sgln:5012345.00000.0">
          <attribute id="urn:epcglobal:cbv:mda#name">GS1 Pere et Fils
Pharmacy</attribute>
          <attribute id="urn:epcglobal:cbv:mda#streetAddressOne">1313
Mockingbird Lane</attribute>
          <attribute id="urn:epcglobal:cbv:mda#city">Paris</attribute>
          <attribute id="urn:epcglobal:cbv:mda#state">TX</attribute>
          <attribute id="urn:epcglobal:cbv:mda#postalCode">76543</attribute>
          <attribute id="urn:epcglobal:cbv:mda#countryCode">US</attribute>
        </VocabularyElement>
      </VocabularyElementList>
    </Vocabulary>
  </VocabularyList>
</EPCISMasterData>
</extension>
<gslushc:dscsaTransactionStatement>
  <gslushc:affirmTransactionStatement>true</gslushc:affirmTransactionStatement>
  <gslushc:legalNotice>Seller has complied with each applicable subsection of FDCA Sec.
581(27)(A)-(G). As indicated below, product was purchased directly from the manufacturer,
manufacturer's exclusive distributor or repackager who purchased directly from a
manufacturer.</gslushc:legalNotice>
</gslushc:dscsaTransactionStatement>
</EPCISHeader>
<EPCISBody>
  <EventList>
    <!-- Transaction History (TH) -->
    <ObjectEvent>
      <eventTime>1970-01-01T00:00:00.000Z</eventTime>
      <eventTimeZoneOffset>+00:00</eventTimeZoneOffset>
      <epcList/>
      <action>OBSERVE</action>
      <bizStep>urn:epcglobal:cbv:bizstep:shipping</bizStep>
      <disposition>urn:epcglobal:cbv:disp:in_transit</disposition>
      <readPoint>
        <id>urn:epc:id:sgln:030000.000000.0</id>
      </readPoint>
    </ObjectEvent>
  </EventList>

```

```

    <extension>
      <quantityList>
        <quantityElement>
          <epcClass>urn:epc:idpat:sgtin:030000.0000001.*</epcClass>
          <quantity>50</quantity>
        </quantityElement>
      </quantityList>
      <sourceList>
        <source
type="urn:epcglobal:cbv:sdt:owning_party">urn:epc:id:sgln:030000.000000.0</source>
      </sourceList>
      <destinationList>
        <destination
type="urn:epcglobal:cbv:sdt:owning_party">urn:epc:id:sgln:0614141.00000.0</destination>
      </destinationList>
    </extension>
  </ObjectEvent>
  <!-- Transaction Information (TI) -->
  <ObjectEvent>
    <eventTime>2014-04-05T11:00:00.000-04:00</eventTime>
    <eventTimeZoneOffset>-04:00</eventTimeZoneOffset>
    <epcList/>
    <action>OBSERVE</action>
    <bizStep>urn:epcglobal:cbv:bizstep:shipping</bizStep>
    <disposition>urn:epcglobal:cbv:disp:in_transit</disposition>
    <readPoint>
      <id>urn:epc:id:sgln:0614141.00000.0</id>
    </readPoint>
    <extension>
      <quantityList>
        <quantityElement>
          <epcClass>urn:epc:idpat:sgtin:030000.0000001.*</epcClass>
          <quantity>50</quantity>
        </quantityElement>
      </quantityList>
      <sourceList>
        <source
type="urn:epcglobal:cbv:sdt:owning_party">urn:epc:id:sgln:0614141.00000.0</source>
      </sourceList>
      <destinationList>
        <destination
type="urn:epcglobal:cbv:sdt:owning_party">urn:epc:id:sgln:5012345.00000.0</destination>
      </destinationList>
    </extension>
    <gslushc:directPurchase value="true"/>
  </ObjectEvent>
</EventList>
</EPCISBody>
</epcis:EPCISDocument>

```

3 Direct Purchase Scenario – Example 2

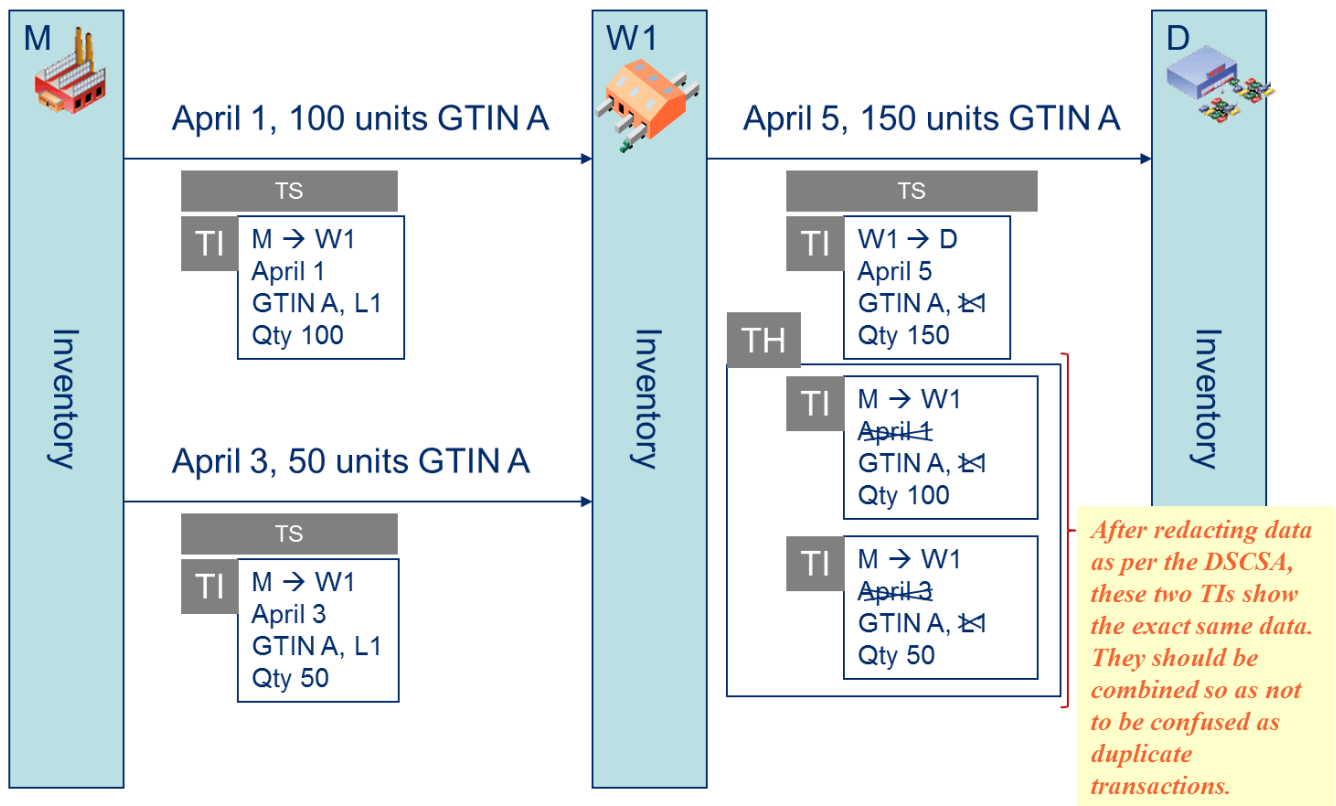

3.1 Sample XML: M → W1, April 1



Note: The message content of M → W1 transaction on April 1 in this example is identical to the content of the M → W1 transaction in [Direct Purchase Example 1](#).

Reference File: <https://resources.gs1us.org/Portals/0/xml/LotChoreo-DirectPurchaseExample2-MtoW1April1.xml>

```
<?xml version="1.0" encoding="UTF-8" standalone="yes"?>
<!-- Lot Choreography End to End Examples: Direct Purchase Example2: M->W1, APRIL 1-->
<!-- Note: this is identical to the contents of Direct Purchase Example1: M->W1, APRIL 1 -->
<epcis:EPCISDocument xmlns:cbvmda="urn:epcglobal:cbv:mda"
xmlns:sbdh="http://www.unece.org/cefact/namespaces/StandardBusinessDocumentHeader"
xmlns:gs1ushc="http://epcis.gs1us.org/hc/ns" xmlns:epcis="urn:epcglobal:epcis:xsd:1"
schemaVersion="1.2" xsi:schemaLocation="urn:epcglobal:epcis:xsd:1 EPCglobal-epcis-1_2.xsd"
xmlns:xsi="http://www.w3.org/2001/XMLSchema-instance" creationDate="2014-05-30T15:14:27.574-
04:00">
  <EPCISHeader>
    <sbdh:StandardBusinessDocumentHeader>
      <sbdh:HeaderVersion>1.0</sbdh:HeaderVersion>
      <sbdh:Sender>
        <sbdh:Identifier
Authority="SGLN">urn:epc:id:sgln:030000.000000.0</sbdh:Identifier>
        </sbdh:Sender>
        <sbdh:Receiver>
          <sbdh:Identifier
Authority="SGLN">urn:epc:id:sgln:0614141.00000.0</sbdh:Identifier>
          </sbdh:Receiver>
          <sbdh:DocumentIdentification>
            <sbdh:Standard>EPCglobal</sbdh:Standard>
            <sbdh:TypeVersion>1.0</sbdh:TypeVersion>
            <sbdh:InstanceIdentifier>1234567890</sbdh:InstanceIdentifier>
            <sbdh:Type>Events</sbdh:Type>
            <sbdh:CreationDateAndTime>2014-05-30T15:14:27.574-04:00</sbdh:CreationDateAndTime>
          </sbdh:DocumentIdentification>
        </sbdh:StandardBusinessDocumentHeader>
        <extension>
          <EPCISMasterData>
            <VocabularyList>
              <Vocabulary type="urn:epcglobal:epcis:vtype:EPCClass">
                <VocabularyElementList>
                  <VocabularyElement id="urn:epc:class:lgtn:030000.0000001.L1">
                    <attribute id="urn:epcglobal:cbv:mda#itemExpirationDate">2015-10-
31</attribute>
                  </VocabularyElement>
                  <VocabularyElement id="urn:epc:idpat:sgtin:030000.0000001.*">
                    <attribute
id="urn:epcglobal:cbv:mda#additionalTradeItemIdentification">00000000001</attribute>
                    <attribute
id="urn:epcglobal:cbv:mda#additionalTradeItemIdentificationTypeCode">FDA_NDC_11</attribute>
                    <attribute
id="urn:epcglobal:cbv:mda#regulatedProductName">Epcistra</attribute>
                    <attribute
id="urn:epcglobal:cbv:mda#manufacturerOfTradeItemPartyName">GS1 Pharma LLC</attribute>
                    <attribute id="urn:epcglobal:cbv:mda#dosageFormType">PILL</attribute>
                    <attribute
id="urn:epcglobal:cbv:mda#strengthDescription">100mg</attribute>
                    <attribute id="urn:epcglobal:cbv:mda#netContentDescription">500
pills</attribute>
                </VocabularyElementList>
              </Vocabulary>
            </EPCISMasterData>
          </extension>
        </EPCISHeader>
      </EPCISDocument>
    </EPCISDocument>
  </EPCISDocument>
</EPCISDocument>
```

```

        </VocabularyElement>
      </VocabularyElementList>
    </Vocabulary>
    <Vocabulary type="urn:epcglobal:epcis:vtype:Location">
      <VocabularyElementList>
        <VocabularyElement id="urn:epc:id:sgln:030000.000000.0">
          <attribute id="urn:epcglobal:cbv:mda#name">GS1 Pharma LLC</attribute>
          <attribute id="urn:epcglobal:cbv:mda#streetAddressOne">1295 S George
Ave</attribute>
          <attribute id="urn:epcglobal:cbv:mda#streetAddressTwo">Room
378</attribute>
          <attribute id="urn:epcglobal:cbv:mda#city">Washington</attribute>
          <attribute id="urn:epcglobal:cbv:mda#state">DC</attribute>
          <attribute id="urn:epcglobal:cbv:mda#postalCode">12345-
6789</attribute>
          <attribute id="urn:epcglobal:cbv:mda#countryCode">US</attribute>
        </VocabularyElement>
        <VocabularyElement id="urn:epc:id:sgln:0614141.00000.0">
          <attribute id="urn:epcglobal:cbv:mda#name">GS1 Drug Distro
LLC</attribute>
          <attribute id="urn:epcglobal:cbv:mda#streetAddressOne">230 Park Ave
S</attribute>
          <attribute id="urn:epcglobal:cbv:mda#city">New York</attribute>
          <attribute id="urn:epcglobal:cbv:mda#state">NY</attribute>
          <attribute id="urn:epcglobal:cbv:mda#postalCode">10003-
1502</attribute>
          <attribute id="urn:epcglobal:cbv:mda#countryCode">US</attribute>
        </VocabularyElement>
      </VocabularyElementList>
    </Vocabulary>
  </VocabularyList>
</EPCISMasterData>
</extension>
<gslushc:dscsaTransactionStatement>
  <gslushc:affirmTransactionStatement>true</gslushc:affirmTransactionStatement>
  <gslushc:legalNotice>Seller has complied with each applicable subsection of FDCA Sec.
581 (27) (A) - (G).</gslushc:legalNotice>
</gslushc:dscsaTransactionStatement>
</EPCISHeader>
<EPCISBody>
  <EventList>
    <!-- Transaction Information (TI) -->
    <ObjectEvent>
      <eventTime>2014-04-01T10:11:12Z</eventTime>
      <eventTimeZoneOffset>-05:00</eventTimeZoneOffset>
      <epcList/>
      <action>OBSERVE</action>
      <bizStep>urn:epcglobal:cbv:bizstep:shipping</bizStep>
      <disposition>urn:epcglobal:cbv:disp:in_transit</disposition>
      <readPoint>
        <id>urn:epc:id:sgln:030000.000000.0</id>
      </readPoint>
      <extension>
        <quantityList>
          <quantityElement>
            <epcClass>urn:epc:class:lgtn:030000.0000001.L1</epcClass>
            <quantity>100</quantity>
          </quantityElement>
        </quantityList>
        <sourceList>

```

```

                <source
type="urn:epcglobal:cbv:sdt:owning_party">urn:epc:id:sgln:030000.000000.0</source>
                </sourceList>
                <destinationList>
                <destination
type="urn:epcglobal:cbv:sdt:owning_party">urn:epc:id:sgln:0614141.000000.0</destination>
                </destinationList>
                </extension>
            </ObjectEvent>
        </EventList>
    </EPCISBody>
</epcis:EPCISDocument>

```

3.2 Sample XML: M → W1, April 3



Note: The M → W1 transaction on April 3 in this example is almost identical to the April 1 transaction: only the date and quantity are different.

Reference File: <https://resources.gs1us.org/Portals/0/xml/LotChoreo-DirectPurchaseExample2-MtoW1April3.xml>

```

<?xml version="1.0" encoding="UTF-8" standalone="yes"?>
<!-- Lot Choreography End to End Examples: Direct Purchase Example2: M->W1, APRIL 3 -->
<epcis:EPCISDocument xmlns:cbvmda="urn:epcglobal:cbv:mda"
xmlns:sbdh="http://www.unece.org/cefact/namespaces/StandardBusinessDocumentHeader"
xmlns:gslushc="http://epcis.gs1us.org/hc/ns" xmlns:epcis="urn:epcglobal:epcis:xsd:1"
schemaVersion="1.2" xsi:schemaLocation="urn:epcglobal:epcis:xsd:1 EPCglobal-epcis-1_2.xsd"
xmlns:xsi="http://www.w3.org/2001/XMLSchema-instance" creationDate="2014-05-30T15:14:27.574-
04:00">
    <EPCISHeader>
        <sbdh:StandardBusinessDocumentHeader>
            <sbdh:HeaderVersion>1.0</sbdh:HeaderVersion>
            <sbdh:Sender>
                <sbdh:Identifier
Authority="SGLN">urn:epc:id:sgln:030000.000000.0</sbdh:Identifier>
            </sbdh:Sender>
            <sbdh:Receiver>
                <sbdh:Identifier
Authority="SGLN">urn:epc:id:sgln:0614141.000000.0</sbdh:Identifier>
            </sbdh:Receiver>
            <sbdh:DocumentIdentification>
                <sbdh:Standard>EPCglobal</sbdh:Standard>
                <sbdh:TypeVersion>1.0</sbdh:TypeVersion>
                <sbdh:InstanceIdentifier>1234567890</sbdh:InstanceIdentifier>
                <sbdh:Type>Events</sbdh:Type>
                <sbdh:CreationDateAndTime>2014-05-30T15:14:27.574-04:00</sbdh:CreationDateAndTime>
            </sbdh:DocumentIdentification>
        </sbdh:StandardBusinessDocumentHeader>
        <extension>
            <EPCISMasterData>
                <VocabularyList>
                    <Vocabulary type="urn:epcglobal:epcis:vtype:EPCClass">
                        <VocabularyElementList>
                            <VocabularyElement id="urn:epc:class:lgtn:030000.0000001.L1">
                                <attribute id="urn:epcglobal:cbv:mda:itemExpirationDate">2015-10-
31</attribute>
                            </VocabularyElement>
                            <VocabularyElement id="urn:epc:idpat:sgtin:030000.0000001.*">

```

```

        <attribute
id="urn:epcglobal:cbv:mda#additionalTradeItemIdentification">0000000001</attribute>
        <attribute
id="urn:epcglobal:cbv:mda#additionalTradeItemIdentificationTypeCode">FDA_NDC_11</attribute>
        <attribute
id="urn:epcglobal:cbv:mda#regulatedProductName">Epcistra</attribute>
        <attribute
id="urn:epcglobal:cbv:mda#manufacturerOfTradeItemPartyName">GS1 Pharma LLC</attribute>
        <attribute id="urn:epcglobal:cbv:mda#dosageFormType">PILL</attribute>
        <attribute
id="urn:epcglobal:cbv:mda#strengthDescription">100mg</attribute>
        <attribute id="urn:epcglobal:cbv:mda#netContentDescription">500
pills</attribute>
    </VocabularyElement>
</VocabularyElementList>
</Vocabulary>
<Vocabulary type="urn:epcglobal:epcis:vtype:Location">
    <VocabularyElementList>
        <VocabularyElement id="urn:epc:id:sgln:030000.000000.0">
            <attribute id="urn:epcglobal:cbv:mda#name">GS1 Pharma LLC</attribute>
            <attribute id="urn:epcglobal:cbv:mda#streetAddressOne">George
Ave</attribute>
            <attribute id="urn:epcglobal:cbv:mda#streetAddressTwo">Room
378</attribute>
            <attribute id="urn:epcglobal:cbv:mda#city">Washington</attribute>
            <attribute id="urn:epcglobal:cbv:mda#state">DC</attribute>
            <attribute id="urn:epcglobal:cbv:mda#postalCode">12345-
6789</attribute>
            <attribute id="urn:epcglobal:cbv:mda#countryCode">US</attribute>
        </VocabularyElement>
        <VocabularyElement id="urn:epc:id:sgln:0614141.000000.0">
            <attribute id="urn:epcglobal:cbv:mda#name">GS1 Drug Distro
LLC</attribute>
            <attribute id="urn:epcglobal:cbv:mda#streetAddressOne">230 Park Ave
S</attribute>
            <attribute id="urn:epcglobal:cbv:mda#city">New York</attribute>
            <attribute id="urn:epcglobal:cbv:mda#state">NY</attribute>
            <attribute id="urn:epcglobal:cbv:mda#postalCode">10003-
1502</attribute>
            <attribute id="urn:epcglobal:cbv:mda#countryCode">US</attribute>
        </VocabularyElement>
    </VocabularyElementList>
</Vocabulary>
</VocabularyList>
</EPCISMasterData>
</extension>
<gslushc:dscsaTransactionStatement>
    <gslushc:affirmTransactionStatement>true</gslushc:affirmTransactionStatement>
    <gslushc:legalNotice>Seller has complied with each applicable subsection of FDCA Sec.
581 (27) (A) - (G).</gslushc:legalNotice>
</gslushc:dscsaTransactionStatement>
</EPCISHeader>
<EPCISBody>
    <EventList>
        <!-- Transaction Information (TI) -->
        <ObjectEvent>
            <eventTime>2014-04-03T12:13:14Z</eventTime>
            <eventTimeZoneOffset>-05:00</eventTimeZoneOffset>
            <epcList/>
            <action>OBSERVE</action>
            <bizStep>urn:epcglobal:cbv:bizstep:shipping</bizStep>

```



```

<disposition>urn:epcglobal:cbv:disp:in_transit</disposition>
<readPoint>
  <id>urn:epc:id:sgln:030000.000000.0</id>
</readPoint>
<extension>
  <quantityList>
    <quantityElement>
      <epcClass>urn:epc:class:lgtin:030000.0000001.L1</epcClass>
      <quantity>50</quantity>
    </quantityElement>
  </quantityList>
  <sourceList>
    <source
type="urn:epcglobal:cbv:sdt:owning_party">urn:epc:id:sgln:030000.000000.0</source>
  </sourceList>
  <destinationList>
    <destination
type="urn:epcglobal:cbv:sdt:owning_party">urn:epc:id:sgln:0614141.00000.0</destination>
  </destinationList>
</extension>
</ObjectEvent>
</EventList>
</EPCISBody>
</epcis:EPCISDocument>

```

3.3 Sample XML: W1 → D



Note: While the history of product moving from M to W1 is different in Direct Purchase Example 2 compared to Direct Purchase Example 1, the redaction allowed by DSCSA results in the information that W1 sends to D being almost identical to the XML for [Direct Purchase Example 1](#) except for the difference in quantity.

Reference File: <https://resources.gs1us.org/Portals/0/xml/LotChoreo-DirectPurchaseExample2-W1toD.xml>

```

<?xml version="1.0" encoding="UTF-8" standalone="yes"?>
<!-- Lot Choreography End to End Examples: Direct Purchase Example2: W1->D -->
<epcis:EPCISDocument xmlns:cbvmda="urn:epcglobal:cbv:mda"
xmlns:sbdh="http://www.unece.org/cefact/namespaces/StandardBusinessDocumentHeader"
xmlns:gslushc="http://epcis.gs1us.org/hc/ns" xmlns:epcis="urn:epcglobal:epcis:xsd:1"
schemaVersion="1.2" xsi:schemaLocation="urn:epcglobal:epcis:xsd:1 EPCglobal-epcis-1_2.xsd"
xmlns:xsi="http://www.w3.org/2001/XMLSchema-instance" creationDate="2014-05-30T15:14:27.574-
04:00">
  <EPCISHeader>
    <sbdh:StandardBusinessDocumentHeader>
      <sbdh:HeaderVersion>1.0</sbdh:HeaderVersion>
      <sbdh:Sender>
        <sbdh:Identifier
Authority="SGLN">urn:epc:id:sgln:0614141.00000.0</sbdh:Identifier>
      </sbdh:Sender>
      <sbdh:Receiver>
        <sbdh:Identifier
Authority="SGLN">urn:epc:id:sgln:5012345.00000.0</sbdh:Identifier>
      </sbdh:Receiver>
      <sbdh:DocumentIdentification>
        <sbdh:Standard>EPCglobal</sbdh:Standard>
        <sbdh:TypeVersion>1.0</sbdh:TypeVersion>
        <sbdh:InstanceIdentifier>1234567890</sbdh:InstanceIdentifier>

```

```

        <sbdh:Type>Events</sbdh:Type>
        <sbdh:CreationDateAndTime>2014-05-30T15:14:27.574-04:00</sbdh:CreationDateAndTime>
    </sbdh:DocumentIdentification>
</sbdh:StandardBusinessDocumentHeader>
<extension>
    <EPCISMasterData>
        <VocabularyList>
            <Vocabulary type="urn:epcglobal:epcis:vtype:EPCClass">
                <VocabularyElementList>
                    <VocabularyElement id="urn:epc:idpat:sgtin:030000.0000001.*">
                        <attribute
id="urn:epcglobal:cbv:mda#additionalTradeItemIdentification">00000000001</attribute>
                        <attribute
id="urn:epcglobal:cbv:mda#additionalTradeItemIdentificationTypeCode">FDA_NDC_11</attribute>
                        <attribute
id="urn:epcglobal:cbv:mda#regulatedProductName">Epcistra</attribute>
                        <attribute
id="urn:epcglobal:cbv:mda#manufacturerOfTradeItemPartyName">GS1 Pharma LLC</attribute>
                        <attribute id="urn:epcglobal:cbv:mda#dosageFormType">PILL</attribute>
                        <attribute
id="urn:epcglobal:cbv:mda#strengthDescription">100mg</attribute>
                        <attribute id="urn:epcglobal:cbv:mda#netContentDescription">500
pills</attribute>
                    </VocabularyElement>
                </VocabularyElementList>
            </Vocabulary>
            <Vocabulary type="urn:epcglobal:epcis:vtype:Location">
                <VocabularyElementList>
                    <VocabularyElement id="urn:epc:id:sgln:030000.000000.0">
                        <attribute id="urn:epcglobal:cbv:mda#name">GS1 Pharma LLC</attribute>
                        <attribute id="urn:epcglobal:cbv:mda#streetAddressOne">1295 S George
Ave</attribute>
                        <attribute id="urn:epcglobal:cbv:mda#streetAddressTwo">Room
378</attribute>
                        <attribute id="urn:epcglobal:cbv:mda#city">Washington</attribute>
                        <attribute id="urn:epcglobal:cbv:mda#state">DC</attribute>
                        <attribute id="urn:epcglobal:cbv:mda#postalCode">12345-
6789</attribute>
                        <attribute id="urn:epcglobal:cbv:mda#countryCode">US</attribute>
                    </VocabularyElement>
                    <VocabularyElement id="urn:epc:id:sgln:0614141.00000.0">
                        <attribute id="urn:epcglobal:cbv:mda#name">GS1 Drug Distro
LLC</attribute>
                        <attribute id="urn:epcglobal:cbv:mda#streetAddressOne">230 Park Ave
S</attribute>
                        <attribute id="urn:epcglobal:cbv:mda#city">New York</attribute>
                        <attribute id="urn:epcglobal:cbv:mda#state">NY</attribute>
                        <attribute id="urn:epcglobal:cbv:mda#postalCode">10003-
1502</attribute>
                        <attribute id="urn:epcglobal:cbv:mda#countryCode">US</attribute>
                    </VocabularyElement>
                    <VocabularyElement id="urn:epc:id:sgln:5012345.00000.0">
                        <attribute id="urn:epcglobal:cbv:mda#name">GS1 Pere et Fils
Pharmacy</attribute>
                        <attribute id="urn:epcglobal:cbv:mda#streetAddressOne">1313
Mockingbird Lane</attribute>
                        <attribute id="urn:epcglobal:cbv:mda#city">Paris</attribute>
                        <attribute id="urn:epcglobal:cbv:mda#state">TX</attribute>
                        <attribute id="urn:epcglobal:cbv:mda#postalCode">76543</attribute>
                        <attribute id="urn:epcglobal:cbv:mda#countryCode">US</attribute>
                    </VocabularyElement>
                </VocabularyElementList>
            </Vocabulary>
        </VocabularyList>
    </EPCISMasterData>
</extension>

```

```

        </VocabularyElementList>
    </Vocabulary>
</VocabularyList>
</EPCISMasterData>
</extension>
<gslushc:dscsaTransactionStatement>
    <gslushc:affirmTransactionStatement>true</gslushc:affirmTransactionStatement>
    <gslushc:legalNotice>Seller has complied with each applicable subsection of FDCA Sec.
581(27)(A)-(G). As indicated below, product was purchased directly from the manufacturer,
manufacturer's exclusive distributor or repackager who purchased directly from a
manufacturer.</gslushc:legalNotice>
    </gslushc:dscsaTransactionStatement>
</EPCISHeader>
<EPCISBody>
    <EventList>
        <!-- Transaction History (TH) -->
        <ObjectEvent>
            <eventTime>1970-01-01T00:00:00.000Z</eventTime>
            <eventTimeZoneOffset>+00:00</eventTimeZoneOffset>
            <epcList/>
            <action>OBSERVE</action>
            <bizStep>urn:epcglobal:cbv:bizstep:shipping</bizStep>
            <disposition>urn:epcglobal:cbv:disp:in_transit</disposition>
            <readPoint>
                <id>urn:epc:id:sgln:030000.000000.0</id>
            </readPoint>
            <extension>
                <quantityList>
                    <quantityElement>
                        <epcClass>urn:epc:idpat:sgtin:030000.0000001.*</epcClass>
                        <!-- After redacting transaction date and lot, the TIs can be combined
with a sum quantity of 150 as shown in the diagram -->
                        <quantity>150</quantity>
                    </quantityElement>
                </quantityList>
                <sourceList>
                    <source
type="urn:epcglobal:cbv:sdt:owning_party">urn:epc:id:sgln:030000.000000.0</source>
                </sourceList>
                <destinationList>
                    <destination
type="urn:epcglobal:cbv:sdt:owning_party">urn:epc:id:sgln:0614141.00000.0</destination>
                </destinationList>
            </extension>
        </ObjectEvent>
        <!-- Transaction Information (TI) -->
        <ObjectEvent>
            <eventTime>2014-04-05T11:00:00.000-04:00</eventTime>
            <eventTimeZoneOffset>-04:00</eventTimeZoneOffset>
            <epcList/>
            <action>OBSERVE</action>
            <bizStep>urn:epcglobal:cbv:bizstep:shipping</bizStep>
            <disposition>urn:epcglobal:cbv:disp:in_transit</disposition>
            <readPoint>
                <id>urn:epc:id:sgln:0614141.00000.0</id>
            </readPoint>
            <extension>
                <quantityList>
                    <quantityElement>
                        <epcClass>urn:epc:idpat:sgtin:030000.0000001.*</epcClass>
                        <quantity>150</quantity>
                    </quantityElement>
                </quantityList>
            </extension>
        </ObjectEvent>
    </EventList>
</EPCISBody>
</EPCIS>

```

```
        </quantityElement>
    </quantityList>
    <sourceList>
        <source
type="urn:epcglobal:cbv:sdt:owning_party">urn:epc:id:sgln:0614141.00000.0</source>
        </sourceList>
    <destinationList>
        <destination
type="urn:epcglobal:cbv:sdt:owning_party">urn:epc:id:sgln:5012345.00000.0</destination>
        </destinationList>
    </extension>
    <gslushc:directPurchase value="true"/>
</ObjectEvent>
</EventList>
</EPCISBody>
</epcis:EPCISDocument>
```

4 Direct Purchase Scenario – Example 3

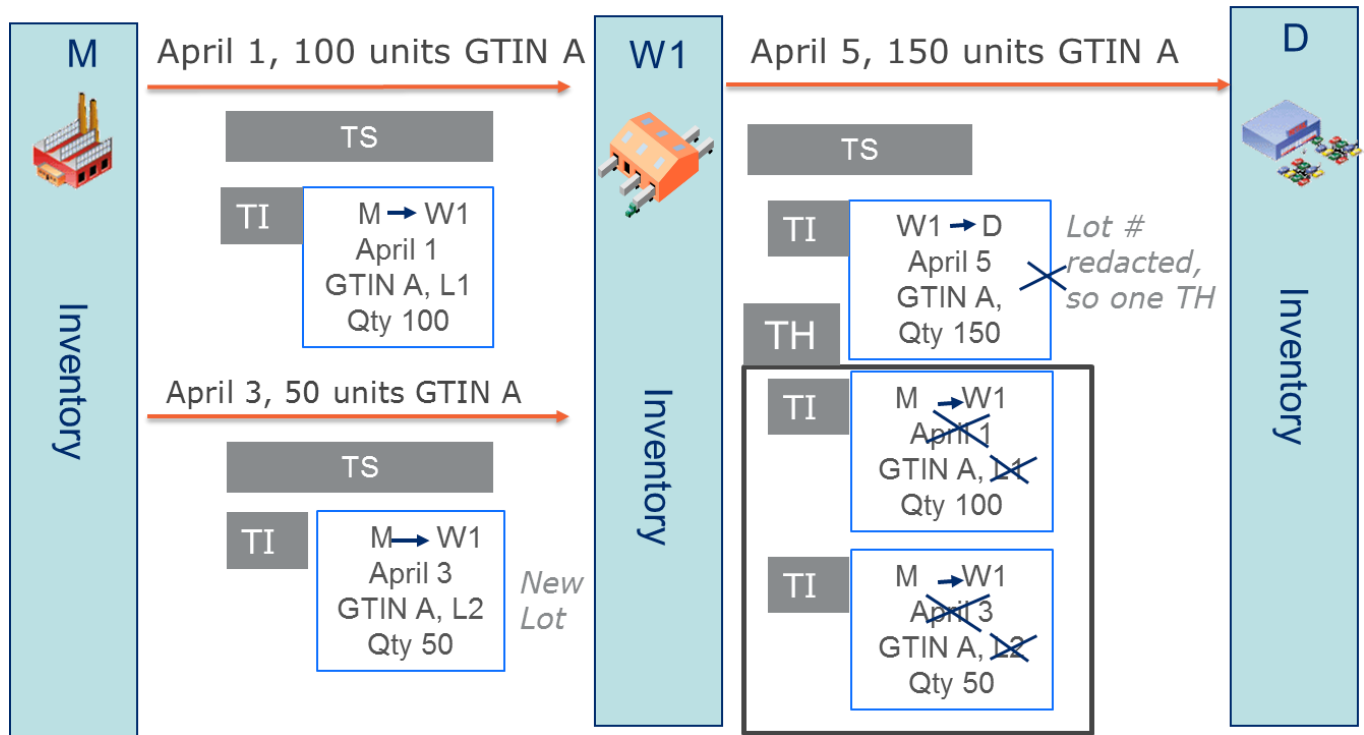

4.1 Sample XML: M → W1, April 1



Note: The message content of the M → W1 transaction on April 1 in this example is identical to the content of the M → W1 transaction in [Direct Purchase Example 1](#).

Reference File: <https://resources.gs1us.org/Portals/0/xml/LotChoreo-DirectPurchaseExample3-MtoW1April1.xml>

```
<?xml version="1.0" encoding="UTF-8" standalone="yes"?>
<!-- Lot Choreography End to End Examples: Direct Purchase Example3: M->W1, APRIL 1 -->
<!-- Note: this is identical to the contents of Direct Purchase Example1: M->W1, APRIL 1 -->
<epcis:EPCISDocument xmlns:cbvmda="urn:epcglobal:cbv:mda"
xmlns:sbdh="http://www.unece.org/cefact/namespaces/StandardBusinessDocumentHeader"
xmlns:gs1ushc="http://epcis.gs1us.org/hc/ns" xmlns:epcis="urn:epcglobal:epcis:xsd:1"
schemaVersion="1.2" xsi:schemaLocation="urn:epcglobal:epcis:xsd:1 EPCglobal-epcis-1_2.xsd"
xmlns:xsi="http://www.w3.org/2001/XMLSchema-instance" creationDate="2014-05-30T15:14:27.574-
04:00">
  <EPCISHeader>
    <sbdh:StandardBusinessDocumentHeader>
      <sbdh:HeaderVersion>1.0</sbdh:HeaderVersion>
      <sbdh:Sender>
        <sbdh:Identifier
Authority="SGLN">urn:epc:id:sgln:030000.000000.0</sbdh:Identifier>
        </sbdh:Sender>
        <sbdh:Receiver>
          <sbdh:Identifier
Authority="SGLN">urn:epc:id:sgln:0614141.00000.0</sbdh:Identifier>
          </sbdh:Receiver>
          <sbdh:DocumentIdentification>
            <sbdh:Standard>EPCglobal</sbdh:Standard>
            <sbdh:TypeVersion>1.0</sbdh:TypeVersion>
            <sbdh:InstanceIdentifier>1234567890</sbdh:InstanceIdentifier>
            <sbdh:Type>Events</sbdh:Type>
            <sbdh:CreationDateAndTime>2014-05-30T15:14:27.574-04:00</sbdh:CreationDateAndTime>
          </sbdh:DocumentIdentification>
        </sbdh:StandardBusinessDocumentHeader>
        <extension>
          <EPCISMasterData>
            <VocabularyList>
              <Vocabulary type="urn:epcglobal:epcis:vtype:EPCClass">
                <VocabularyElementList>
                  <VocabularyElement id="urn:epc:class:lgtn:030000.0000001.L1">
                    <attribute id="urn:epcglobal:cbv:mda#itemExpirationDate">2015-10-
31</attribute>
                  </VocabularyElement>
                  <VocabularyElement id="urn:epc:idpat:sgtin:030000.0000001.*">
                    <attribute
id="urn:epcglobal:cbv:mda#additionalTradeItemIdentification">00000000001</attribute>
                    <attribute
id="urn:epcglobal:cbv:mda#additionalTradeItemIdentificationTypeCode">FDA_NDC_11</attribute>
                    <attribute
id="urn:epcglobal:cbv:mda#regulatedProductName">Epcistra</attribute>
                    <attribute
id="urn:epcglobal:cbv:mda#manufacturerOfTradeItemPartyName">GS1 Pharma LLC</attribute>
                    <attribute id="urn:epcglobal:cbv:mda#dosageFormType">PILL</attribute>
                    <attribute
id="urn:epcglobal:cbv:mda#strengthDescription">100mg</attribute>
                    <attribute id="urn:epcglobal:cbv:mda#netContentDescription">500
pills</attribute>
                </VocabularyElementList>
              </Vocabulary>
            </EPCISMasterData>
          </extension>
        </EPCISHeader>
      </EPCISDocument>
    </EPCISDocument>
  </EPCISDocument>
</EPCISDocument>
```

```

        </VocabularyElement>
      </VocabularyElementList>
    </Vocabulary>
    <Vocabulary type="urn:epcglobal:epcis:vtype:Location">
      <VocabularyElementList>
        <VocabularyElement id="urn:epc:id:sgln:030000.000000.0">
          <attribute id="urn:epcglobal:cbv:mda#name">GS1 Pharma LLC</attribute>
          <attribute id="urn:epcglobal:cbv:mda#streetAddressOne">1295 S George
Ave</attribute>
          <attribute id="urn:epcglobal:cbv:mda#streetAddressTwo">Room
378</attribute>
          <attribute id="urn:epcglobal:cbv:mda#city">Washington</attribute>
          <attribute id="urn:epcglobal:cbv:mda#state">DC</attribute>
          <attribute id="urn:epcglobal:cbv:mda#postalCode">12345-
6789</attribute>
          <attribute id="urn:epcglobal:cbv:mda#countryCode">US</attribute>
        </VocabularyElement>
        <VocabularyElement id="urn:epc:id:sgln:0614141.00000.0">
          <attribute id="urn:epcglobal:cbv:mda#name">GS1 Drug Distro
LLC</attribute>
          <attribute id="urn:epcglobal:cbv:mda#streetAddressOne">230 Park Ave
S</attribute>
          <attribute id="urn:epcglobal:cbv:mda#city">New York</attribute>
          <attribute id="urn:epcglobal:cbv:mda#state">NY</attribute>
          <attribute id="urn:epcglobal:cbv:mda#postalCode">10003-
1502</attribute>
          <attribute id="urn:epcglobal:cbv:mda#countryCode">US</attribute>
        </VocabularyElement>
      </VocabularyElementList>
    </Vocabulary>
  </VocabularyList>
</EPCISMasterData>
</extension>
<gslushc:dscsaTransactionStatement>
  <gslushc:affirmTransactionStatement>true</gslushc:affirmTransactionStatement>
  <gslushc:legalNotice>Seller has complied with each applicable subsection of FDCA Sec.
581 (27) (A) - (G).</gslushc:legalNotice>
</gslushc:dscsaTransactionStatement>
</EPCISHeader>
<EPCISBody>
  <EventList>
    <!-- Transaction Information (TI) -->
    <ObjectEvent>
      <eventTime>2014-04-01T10:11:12Z</eventTime>
      <eventTimeZoneOffset>-05:00</eventTimeZoneOffset>
      <epcList/>
      <action>OBSERVE</action>
      <bizStep>urn:epcglobal:cbv:bizstep:shipping</bizStep>
      <disposition>urn:epcglobal:cbv:disp:in_transit</disposition>
      <readPoint>
        <id>urn:epc:id:sgln:030000.000000.0</id>
      </readPoint>
      <extension>
        <quantityList>
          <quantityElement>
            <epcClass>urn:epc:class:lgtn:030000.0000001.L1</epcClass>
            <quantity>100</quantity>
          </quantityElement>
        </quantityList>
        <sourceList>

```

```

                <source
type="urn:epcglobal:cbv:sdt:owning_party">urn:epc:id:sgln:030000.000000.0</source>
                </sourceList>
                <destinationList>
                <destination
type="urn:epcglobal:cbv:sdt:owning_party">urn:epc:id:sgln:0614141.000000.0</destination>
                </destinationList>
                </extension>
            </ObjectEvent>
        </EventList>
    </EPCISBody>
</epcis:EPCISDocument>

```

4.2 Sample XML: M → W1, April 3



Note: The M → W1 transaction on April 3 in this example is almost identical to the April 1 transaction -- only the date, quantity, and lot number are different. Compared to the M → W1 transaction on April 3 in [Direct Purchase Example 2](#), only the lot number is different.

Reference File: <https://resources.gs1us.org/Portals/0/xml/LotChoreo-DirectPurchaseExample3-MtoW1April3.xml>

```

<?xml version="1.0" encoding="UTF-8" standalone="yes"?>
<!-- Lot Choreography End to End Examples: Direct Purchase Example3: M->W1, APRIL 3 -->
<epcis:EPCISDocument xmlns:cbvmda="urn:epcglobal:cbv:mda"
xmlns:sbdh="http://www.unece.org/cefact/namespaces/StandardBusinessDocumentHeader"
xmlns:gslushc="http://epcis.gs1us.org/hc/ns" xmlns:epcis="urn:epcglobal:epcis:xsd:1"
schemaVersion="1.2" xsi:schemaLocation="urn:epcglobal:epcis:xsd:1 EPCglobal-epcis-1_2.xsd"
xmlns:xsi="http://www.w3.org/2001/XMLSchema-instance" creationDate="2014-05-30T15:14:27.574-
04:00">
    <EPCISHeader>
        <sbdh:StandardBusinessDocumentHeader>
            <sbdh:HeaderVersion>1.0</sbdh:HeaderVersion>
            <sbdh:Sender>
                <sbdh:Identifier
Authority="SGLN">urn:epc:id:sgln:030000.000000.0</sbdh:Identifier>
            </sbdh:Sender>
            <sbdh:Receiver>
                <sbdh:Identifier
Authority="SGLN">urn:epc:id:sgln:0614141.000000.0</sbdh:Identifier>
            </sbdh:Receiver>
            <sbdh:DocumentIdentification>
                <sbdh:Standard>EPCglobal</sbdh:Standard>
                <sbdh:TypeVersion>1.0</sbdh:TypeVersion>
                <sbdh:InstanceIdentifier>1234567890</sbdh:InstanceIdentifier>
                <sbdh:Type>Events</sbdh:Type>
                <sbdh:CreationDateAndTime>2014-05-30T15:14:27.574-04:00</sbdh:CreationDateAndTime>
            </sbdh:DocumentIdentification>
        </sbdh:StandardBusinessDocumentHeader>
        <extension>
            <EPCISMasterData>
                <VocabularyList>
                    <Vocabulary type="urn:epcglobal:epcis:vtype:EPCClass">
                        <VocabularyElementList>
                            <VocabularyElement id="urn:epc:class:lgtin:030000.0000001.L2">
                                <attribute id="urn:epcglobal:cbv:mda:itemExpirationDate">2016-02-
29</attribute>
                            </VocabularyElement>

```



```

        <VocabularyElement id="urn:epc:idpat:sgtin:030000.0000001.*">
            <attribute
id="urn:epcglobal:cbv:mda#additionalTradeItemIdentification">0000000001</attribute>
            <attribute
id="urn:epcglobal:cbv:mda#additionalTradeItemIdentificationTypeCode">FDA_NDC_11</attribute>
            <attribute
id="urn:epcglobal:cbv:mda#manufacturerOfTradeItemPartyName">GS1 Pharma LLC</attribute>
            <attribute
id="urn:epcglobal:cbv:mda#regulatedProductName">Epcistra</attribute>
            <attribute id="urn:epcglobal:cbv:mda#dosageFormType">PILL</attribute>
            <attribute
id="urn:epcglobal:cbv:mda#strengthDescription">100mg</attribute>
            <attribute id="urn:epcglobal:cbv:mda#netContentDescription">500
pills</attribute>
        </VocabularyElement>
    </VocabularyElementList>
</Vocabulary>
<Vocabulary type="urn:epcglobal:epcis:vtype:Location">
    <VocabularyElementList>
        <VocabularyElement id="urn:epc:id:sgln:030000.000000.0">
            <attribute id="urn:epcglobal:cbv:mda#name">GS1 Pharma LLC</attribute>
            <attribute id="urn:epcglobal:cbv:mda#streetAddressOne">1295 S George
Ave</attribute>
            <attribute id="urn:epcglobal:cbv:mda#streetAddressTwo">Room
378</attribute>
            <attribute id="urn:epcglobal:cbv:mda#city">Washington</attribute>
            <attribute id="urn:epcglobal:cbv:mda#state">DC</attribute>
            <attribute id="urn:epcglobal:cbv:mda#postalCode">12345-
6789</attribute>
            <attribute id="urn:epcglobal:cbv:mda#countryCode">US</attribute>
        </VocabularyElement>
        <VocabularyElement id="urn:epc:id:sgln:0614141.00000.0">
            <attribute id="urn:epcglobal:cbv:mda#name">GS1 Drug Distro
LLC</attribute>
            <attribute id="urn:epcglobal:cbv:mda#streetAddressOne">230 Park Ave
S</attribute>
            <attribute id="urn:epcglobal:cbv:mda#city">New York</attribute>
            <attribute id="urn:epcglobal:cbv:mda#state">NY</attribute>
            <attribute id="urn:epcglobal:cbv:mda#postalCode">10003-
1502</attribute>
            <attribute id="urn:epcglobal:cbv:mda#countryCode">US</attribute>
        </VocabularyElement>
    </VocabularyElementList>
</Vocabulary>
</VocabularyList>
</EPCISMasterData>
</extension>
<gslushc:dscsaTransactionStatement>
    <gslushc:affirmTransactionStatement>true</gslushc:affirmTransactionStatement>
    <gslushc:legalNotice>Seller has complied with each applicable subsection of FDCA Sec.
581 (27) (A) - (G).</gslushc:legalNotice>
</gslushc:dscsaTransactionStatement>
</EPCISHeader>
<EPCISBody>
    <EventList>
        <!-- Transaction Information (TI) -->
        <ObjectEvent>
            <eventTime>2014-04-03T12:13:14Z</eventTime>
            <eventTimeZoneOffset>-05:00</eventTimeZoneOffset>
            <epcList/>
            <action>OBSERVE</action>

```

```

<bizStep>urn:epcglobal:cbv:bizstep:shipping</bizStep>
<disposition>urn:epcglobal:cbv:disp:in_transit</disposition>
<readPoint>
  <id>urn:epc:id:sgln:030000.000000.0</id>
</readPoint>
<extension>
  <quantityList>
    <quantityElement>
      <epcClass>urn:epc:class:lgtn:030000.0000001.L2</epcClass>
      <quantity>50</quantity>
    </quantityElement>
  </quantityList>
  <sourceList>
    <source
type="urn:epcglobal:cbv:sdt:owning_party">urn:epc:id:sgln:030000.000000.0</source>
    </sourceList>
  <destinationList>
    <destination
type="urn:epcglobal:cbv:sdt:owning_party">urn:epc:id:sgln:0614141.00000.0</destination>
    </destinationList>
  </extension>
</ObjectEvent>
</EventList>
</EPCISBody>
</epcis:EPCISDocument>

```

4.3 Sample XML: W1 → D



Note: While the history of product moving from M to W1 is different in Direct Purchase Example 3 compared to Direct Purchase Example 1, and also different compared to Direct Purchase Example 2 because of different lot numbers, the redaction allowed by DSCSA makes the information that W1 sends to D identical. Therefore, the XML example for the W1 → D is identical to the W1 → D transaction in [Direct Purchase Example 2](#).

Reference File: <https://resources.gs1us.org/Portals/0/xml/LotChoreo-DirectPurchaseExample3-W1toD.xml>

```

<?xml version="1.0" encoding="UTF-8" standalone="yes"?>
<!-- Lot Choreography End to End Examples: Direct Purchase Example3: W1->D -->
<epcis:EPCISDocument xmlns:cbvmda="urn:epcglobal:cbv:mda"
xmlns:sbdh="http://www.unece.org/cefact/namespaces/StandardBusinessDocumentHeader"
xmlns:gslushc="http://epcis.gs1us.org/hc/ns" xmlns:epcis="urn:epcglobal:epcis:xsd:1"
schemaVersion="1.2" xsi:schemaLocation="urn:epcglobal:epcis:xsd:1 EPCglobal-epcis-1_2.xsd"
xmlns:xsi="http://www.w3.org/2001/XMLSchema-instance" creationDate="2014-05-30T15:14:27.574-
04:00">
  <EPCISHeader>
    <sbdh:StandardBusinessDocumentHeader>
      <sbdh:HeaderVersion>1.0</sbdh:HeaderVersion>
      <sbdh:Sender>
        <sbdh:Identifier
Authority="SGLN">urn:epc:id:sgln:0614141.00000.0</sbdh:Identifier>
      </sbdh:Sender>
      <sbdh:Receiver>
        <sbdh:Identifier
Authority="SGLN">urn:epc:id:sgln:5012345.00000.0</sbdh:Identifier>
      </sbdh:Receiver>
      <sbdh:DocumentIdentification>
        <sbdh:Standard>EPCglobal</sbdh:Standard>

```

```

    <sbdh:TypeVersion>1.0</sbdh:TypeVersion>
    <sbdh:InstanceIdentifier>1234567890</sbdh:InstanceIdentifier>
    <sbdh:Type>Events</sbdh:Type>
    <sbdh:CreationDateAndTime>2014-05-30T15:14:27.574-04:00</sbdh:CreationDateAndTime>
  </sbdh:DocumentIdentification>
</sbdh:StandardBusinessDocumentHeader>
<extension>
  <EPCISMasterData>
    <VocabularyList>
      <Vocabulary type="urn:epcglobal:epcis:vtype:EPCClass">
        <VocabularyElementList>
          <VocabularyElement id="urn:epc:idpat:sgtin:030000.0000001.*">
            <attribute
id="urn:epcglobal:cbv:mda#additionalTradeItemIdentification">0000000001</attribute>
            <attribute
id="urn:epcglobal:cbv:mda#additionalTradeItemIdentificationTypeCode">FDA_NDC_11</attribute>
            <attribute
id="urn:epcglobal:cbv:mda#regulatedProductName">Epcistra</attribute>
            <attribute
id="urn:epcglobal:cbv:mda#manufacturerOfTradeItemPartyName">GS1 Pharma LLC</attribute>
            <attribute id="urn:epcglobal:cbv:mda#dosageFormType">PILL</attribute>
            <attribute
id="urn:epcglobal:cbv:mda#strengthDescription">100mg</attribute>
            <attribute id="urn:epcglobal:cbv:mda#netContentDescription">500
pills</attribute>
          </VocabularyElement>
        </VocabularyElementList>
      </Vocabulary>
      <Vocabulary type="urn:epcglobal:epcis:vtype:Location">
        <VocabularyElementList>
          <VocabularyElement id="urn:epc:id:sgln:030000.000000.0">
            <attribute id="urn:epcglobal:cbv:mda#name">GS1 Pharma LLC</attribute>
            <attribute id="urn:epcglobal:cbv:mda#streetAddressOne">1295 S George
Ave</attribute>
            <attribute id="urn:epcglobal:cbv:mda#streetAddressTwo">Room
378</attribute>
            <attribute id="urn:epcglobal:cbv:mda#city">Washington</attribute>
            <attribute id="urn:epcglobal:cbv:mda#state">DC</attribute>
            <attribute id="urn:epcglobal:cbv:mda#postalCode">12345-
6789</attribute>
            <attribute id="urn:epcglobal:cbv:mda#countryCode">US</attribute>
          </VocabularyElement>
          <VocabularyElement id="urn:epc:id:sgln:0614141.00000.0">
            <attribute id="urn:epcglobal:cbv:mda#name">GS1 Drug Distro
LLC</attribute>
            <attribute id="urn:epcglobal:cbv:mda#streetAddressOne">230 Park Ave
S</attribute>
            <attribute id="urn:epcglobal:cbv:mda#city">New York</attribute>
            <attribute id="urn:epcglobal:cbv:mda#state">NY</attribute>
            <attribute id="urn:epcglobal:cbv:mda#postalCode">10003-
1502</attribute>
            <attribute id="urn:epcglobal:cbv:mda#countryCode">US</attribute>
          </VocabularyElement>
          <VocabularyElement id="urn:epc:id:sgln:5012345.00000.0">
            <attribute id="urn:epcglobal:cbv:mda#name">GS1 Pere et Fils
Pharmacy</attribute>
            <attribute id="urn:epcglobal:cbv:mda#streetAddressOne">1313
Mockingbird Lane</attribute>
            <attribute id="urn:epcglobal:cbv:mda#city">Paris</attribute>
            <attribute id="urn:epcglobal:cbv:mda#state">TX</attribute>
            <attribute id="urn:epcglobal:cbv:mda#postalCode">76543</attribute>

```

```

        <attribute id="urn:epcglobal:cbv:mda#countryCode">US</attribute>
      </VocabularyElement>
    </VocabularyElementList>
  </Vocabulary>
</VocabularyList>
</EPCISMasterData>
</extension>
<gslushc:dscsaTransactionStatement>
  <gslushc:affirmTransactionStatement>true</gslushc:affirmTransactionStatement>
  <gslushc:legalNotice>Seller has complied with each applicable subsection of FDCA Sec.
581(27)(A)-(G). As indicated below, product was purchased directly from the manufacturer,
manufacturer's exclusive distributor or repackager who purchased directly from a
manufacturer.</gslushc:legalNotice>
</gslushc:dscsaTransactionStatement>
</EPCISHeader>
<EPCISBody>
  <EventList>
    <!-- Transaction History (TH) -->
    <ObjectEvent>
      <eventTime>1970-01-01T00:00:00.000Z</eventTime>
      <eventTimeZoneOffset>+00:00</eventTimeZoneOffset>
      <epcList/>
      <action>OBSERVE</action>
      <bizStep>urn:epcglobal:cbv:bizstep:shipping</bizStep>
      <disposition>urn:epcglobal:cbv:disp:in_transit</disposition>
      <readPoint>
        <id>urn:epc:id:sgln:030000.000000.0</id>
      </readPoint>
      <extension>
        <quantityList>
          <quantityElement>
            <epcClass>urn:epc:idpat:sgtin:030000.0000001.*</epcClass>
            <!-- After redacting transaction date and lot, the TIs can be combined
with a sum quantity of 150 as shown in the diagram -->
            <quantity>150</quantity>
          </quantityElement>
        </quantityList>
        <sourceList>
          <source
type="urn:epcglobal:cbv:sdt:owning_party">urn:epc:id:sgln:030000.000000.0</source>
        </sourceList>
        <destinationList>
          <destination
type="urn:epcglobal:cbv:sdt:owning_party">urn:epc:id:sgln:0614141.00000.0</destination>
        </destinationList>
      </extension>
    </ObjectEvent>
    <!-- Transaction Information (TI) -->
    <ObjectEvent>
      <eventTime>2014-04-05T11:00:00.000-04:00</eventTime>
      <eventTimeZoneOffset>-04:00</eventTimeZoneOffset>
      <epcList/>
      <action>OBSERVE</action>
      <bizStep>urn:epcglobal:cbv:bizstep:shipping</bizStep>
      <disposition>urn:epcglobal:cbv:disp:in_transit</disposition>
      <readPoint>
        <id>urn:epc:id:sgln:0614141.00000.0</id>
      </readPoint>
      <extension>
        <quantityList>
          <quantityElement>

```

```
        <epcClass>urn:epc:idpat:sgtin:030000.0000001.*</epcClass>
        <quantity>150</quantity>
      </quantityElement>
    </quantityList>
    <sourceList>
      <source
type="urn:epcglobal:cbv:sdt:owning_party">urn:epc:id:sgln:0614141.00000.0</source>
    </sourceList>
    <destinationList>
      <destination
type="urn:epcglobal:cbv:sdt:owning_party">urn:epc:id:sgln:5012345.00000.0</destination>
    </destinationList>
  </extension>
  <gslushc:directPurchase value="true"/>
</ObjectEvent>
</EventList>
</EPCISBody>
</epcis:EPCISDocument>
```

5 Direct Purchase Scenario– Example 4

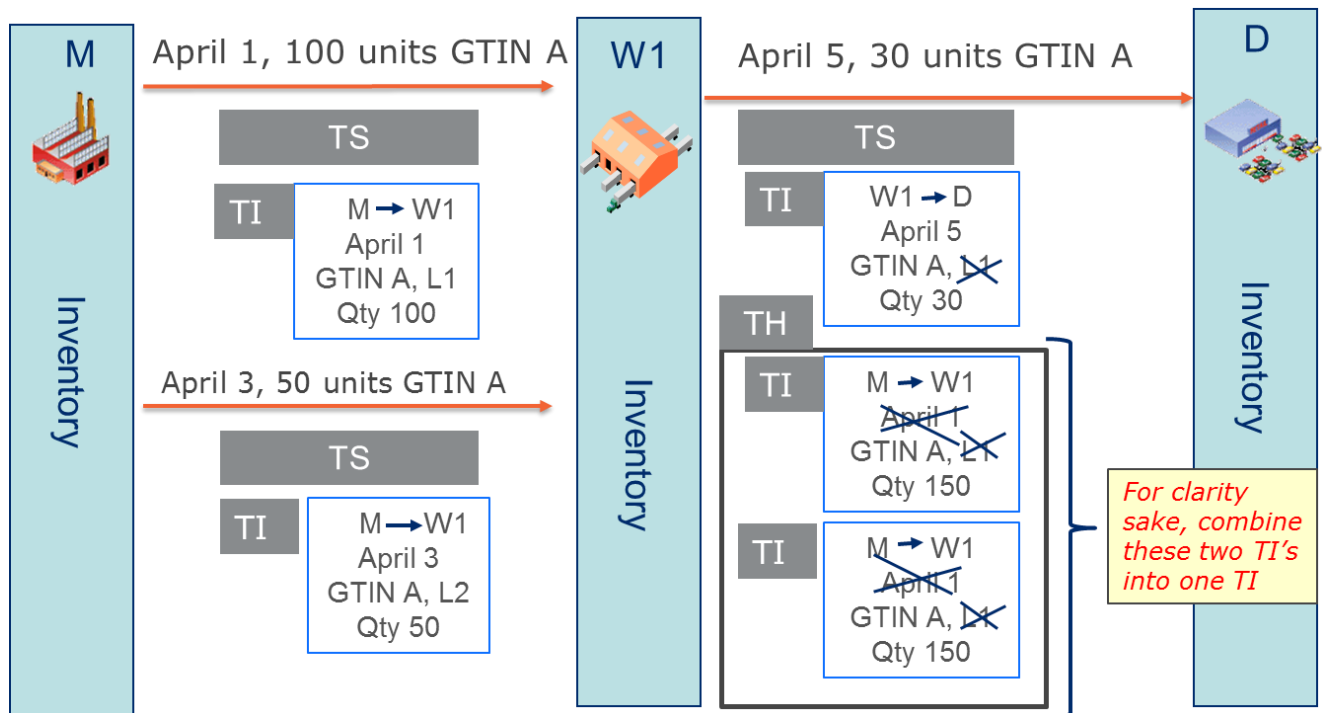

5.1 Sample XML: M → W1, April 1

 **Note:** The message content of the M → W1 transaction on April 1 in this example is identical to the content of the M → W1 transaction in [Direct Purchase Example 1](#).

Reference File: <https://resources.gs1us.org/Portals/0/xml/LotChoreo-DirectPurchaseExample4-MtoW1April1.xml>

```
<?xml version="1.0" encoding="UTF-8" standalone="yes"?>
<!-- Lot Choreography End to End Examples: Direct Purchase Example4: M->W1, APRIL 1-->
<!-- Note: this is identical to the contents of Direct Purchase Example1: M->W1, APRIL 1 -->
<epcis:EPCISDocument xmlns:cbvmda="urn:epcglobal:cbv:mda"
xmlns:sbdh="http://www.unece.org/cefact/namespaces/StandardBusinessDocumentHeader"
xmlns:gs1ushc="http://epcis.gs1us.org/hc/ns" xmlns:epcis="urn:epcglobal:epcis:xsd:1"
schemaVersion="1.2" xsi:schemaLocation="urn:epcglobal:epcis:xsd:1 EPCglobal-epcis-1_2.xsd"
xmlns:xsi="http://www.w3.org/2001/XMLSchema-instance" creationDate="2014-05-30T15:14:27.574-
04:00">
  <EPCISHeader>
    <sbdh:StandardBusinessDocumentHeader>
      <sbdh:HeaderVersion>1.0</sbdh:HeaderVersion>
      <sbdh:Sender>
        <sbdh:Identifier
Authority="SGLN">urn:epc:id:sgln:030000.000000.0</sbdh:Identifier>
        </sbdh:Sender>
      <sbdh:Receiver>
        <sbdh:Identifier
Authority="SGLN">urn:epc:id:sgln:0614141.00000.0</sbdh:Identifier>
        </sbdh:Receiver>
      <sbdh:DocumentIdentification>
        <sbdh:Standard>EPCglobal</sbdh:Standard>
        <sbdh:TypeVersion>1.0</sbdh:TypeVersion>
        <sbdh:InstanceIdentifier>1234567890</sbdh:InstanceIdentifier>
        <sbdh:Type>Events</sbdh:Type>
        <sbdh:CreationDateAndTime>2014-05-30T15:14:27.574-04:00</sbdh:CreationDateAndTime>
      </sbdh:DocumentIdentification>
    </sbdh:StandardBusinessDocumentHeader>
    <extension>
      <EPCISMasterData>
        <VocabularyList>
          <Vocabulary type="urn:epcglobal:epcis:vtype:EPCClass">
            <VocabularyElementList>
              <VocabularyElement id="urn:epc:class:lgtn:030000.0000001.L1">
                <attribute id="urn:epcglobal:cbv:mda#itemExpirationDate">2015-10-
31</attribute>
              </VocabularyElement>
              <VocabularyElement id="urn:epc:idpat:sgtin:030000.0000001.*">
                <attribute
id="urn:epcglobal:cbv:mda#additionalTradeItemIdentification">00000000001</attribute>
                <attribute
id="urn:epcglobal:cbv:mda#additionalTradeItemIdentificationTypeCode">FDA_NDC_11</attribute>
                <attribute
id="urn:epcglobal:cbv:mda#regulatedProductName">Epcistra</attribute>
                <attribute
id="urn:epcglobal:cbv:mda#manufacturerOfTradeItemPartyName">GS1 Pharma LLC</attribute>
                <attribute id="urn:epcglobal:cbv:mda#dosageFormType">PILL</attribute>
                <attribute
id="urn:epcglobal:cbv:mda#strengthDescription">100mg</attribute>
                <attribute id="urn:epcglobal:cbv:mda#netContentDescription">500
pills</attribute>
              </VocabularyElement>
            </VocabularyElementList>
          </Vocabulary>
        </EPCISMasterData>
      </extension>
    </EPCISHeader>
  </EPCISDocument>
```

```

        </VocabularyElement>
      </VocabularyElementList>
    </Vocabulary>
    <Vocabulary type="urn:epcglobal:epcis:vtype:Location">
      <VocabularyElementList>
        <VocabularyElement id="urn:epc:id:sgln:030000.000000.0">
          <attribute id="urn:epcglobal:cbv:mda#name">GS1 Pharma LLC</attribute>
          <attribute id="urn:epcglobal:cbv:mda#streetAddressOne">1295 S George
Ave</attribute>
          <attribute id="urn:epcglobal:cbv:mda#streetAddressTwo">Room
378</attribute>
          <attribute id="urn:epcglobal:cbv:mda#city">Washington</attribute>
          <attribute id="urn:epcglobal:cbv:mda#state">DC</attribute>
          <attribute id="urn:epcglobal:cbv:mda#postalCode">12345-
6789</attribute>
          <attribute id="urn:epcglobal:cbv:mda#countryCode">US</attribute>
        </VocabularyElement>
        <VocabularyElement id="urn:epc:id:sgln:0614141.00000.0">
          <attribute id="urn:epcglobal:cbv:mda#name">GS1 Drug Distro
LLC</attribute>
          <attribute id="urn:epcglobal:cbv:mda#streetAddressOne">230 Park Ave
S</attribute>
          <attribute id="urn:epcglobal:cbv:mda#city">New York</attribute>
          <attribute id="urn:epcglobal:cbv:mda#state">NY</attribute>
          <attribute id="urn:epcglobal:cbv:mda#postalCode">10003-
1502</attribute>
          <attribute id="urn:epcglobal:cbv:mda#countryCode">US</attribute>
        </VocabularyElement>
      </VocabularyElementList>
    </Vocabulary>
  </VocabularyList>
</EPCISMasterData>
</extension>
<gslushc:dscsaTransactionStatement>
  <gslushc:affirmTransactionStatement>true</gslushc:affirmTransactionStatement>
  <gslushc:legalNotice>Seller has complied with each applicable subsection of FDCA Sec.
581 (27) (A) - (G).</gslushc:legalNotice>
</gslushc:dscsaTransactionStatement>
</EPCISHeader>
<EPCISBody>
  <EventList>
    <!-- Transaction Information (TI) -->
    <ObjectEvent>
      <eventTime>2014-04-01T10:11:12Z</eventTime>
      <eventTimeZoneOffset>-05:00</eventTimeZoneOffset>
      <epcList/>
      <action>OBSERVE</action>
      <bizStep>urn:epcglobal:cbv:bizstep:shipping</bizStep>
      <disposition>urn:epcglobal:cbv:disp:in_transit</disposition>
      <readPoint>
        <id>urn:epc:id:sgln:030000.000000.0</id>
      </readPoint>
      <extension>
        <quantityList>
          <quantityElement>
            <epcClass>urn:epc:class:lgtn:030000.0000001.L1</epcClass>
            <quantity>100</quantity>
          </quantityElement>
        </quantityList>
        <sourceList>

```



```

                <source
type="urn:epcglobal:cbv:sdt:owning_party">urn:epc:id:sgln:030000.000000.0</source>
                </sourceList>
                <destinationList>
                <destination
type="urn:epcglobal:cbv:sdt:owning_party">urn:epc:id:sgln:0614141.000000.0</destination>
                </destinationList>
                </extension>
            </ObjectEvent>
        </EventList>
    </EPCISBody>
</epcis:EPCISDocument>

```

5.2 Sample XML: M → W1, April 3



Note: The message content of the M → W1 transaction on April 3 in this example is identical to the content of the April 3 M → W1 transaction in [Direct Purchase Example 2](#).

Reference File: <https://resources.gs1us.org/Portals/0/xml/LotChoreo-DirectPurchaseExample4-MtoW1April3.xml>

```

<?xml version="1.0" encoding="UTF-8" standalone="yes"?>
<!-- Lot Choreography End to End Examples: Direct Purchase Example4: M->W1, APRIL 3 -->
<!-- Note: this is identical to the contents of Direct Purchase Example2: M->W1, APRIL 3 -->
<epcis:EPCISDocument xmlns:cbvmda="urn:epcglobal:cbv:mda"
xmlns:sbdh="http://www.unece.org/cefact/namespaces/StandardBusinessDocumentHeader"
xmlns:gslushc="http://epcis.gs1us.org/hc/ns" xmlns:epcis="urn:epcglobal:epcis:xsd:1"
schemaVersion="1.2" xsi:schemaLocation="urn:epcglobal:epcis:xsd:1 EPCglobal-epcis-1_2.xsd"
xmlns:xsi="http://www.w3.org/2001/XMLSchema-instance" creationDate="2014-05-30T15:14:27.574-
04:00">
    <EPCISHeader>
        <sbdh:StandardBusinessDocumentHeader>
            <sbdh:HeaderVersion>1.0</sbdh:HeaderVersion>
            <sbdh:Sender>
                <sbdh:Identifier
Authority="SGLN">urn:epc:id:sgln:030000.000000.0</sbdh:Identifier>
            </sbdh:Sender>
            <sbdh:Receiver>
                <sbdh:Identifier
Authority="SGLN">urn:epc:id:sgln:0614141.000000.0</sbdh:Identifier>
            </sbdh:Receiver>
            <sbdh:DocumentIdentification>
                <sbdh:Standard>EPCglobal</sbdh:Standard>
                <sbdh:TypeVersion>1.0</sbdh:TypeVersion>
                <sbdh:InstanceIdentifier>1234567890</sbdh:InstanceIdentifier>
                <sbdh:Type>Events</sbdh:Type>
                <sbdh:CreationDateAndTime>2014-05-30T15:14:27.574-04:00</sbdh:CreationDateAndTime>
            </sbdh:DocumentIdentification>
        </sbdh:StandardBusinessDocumentHeader>
        <extension>
            <EPCISMasterData>
                <VocabularyList>
                    <Vocabulary type="urn:epcglobal:epcis:vtype:EPCClass">
                        <VocabularyElementList>
                            <VocabularyElement id="urn:epc:class:lgtin:030000.0000001.L1">
                                <attribute id="urn:epcglobal:cbv:mda:itemExpirationDate">2015-10-
31</attribute>
                            </VocabularyElement>
                            <VocabularyElement id="urn:epc:idpat:sgtin:030000.0000001.*">

```

```

        <attribute
id="urn:epcglobal:cbv:mda#additionalTradeItemIdentification">0000000001</attribute>
        <attribute
id="urn:epcglobal:cbv:mda#additionalTradeItemIdentificationTypeCode">FDA_NDC_11</attribute>
        <attribute
id="urn:epcglobal:cbv:mda#regulatedProductName">Epcistra</attribute>
        <attribute
id="urn:epcglobal:cbv:mda#manufacturerOfTradeItemPartyName">GS1 Pharma LLC</attribute>
        <attribute id="urn:epcglobal:cbv:mda#dosageFormType">PILL</attribute>
        <attribute
id="urn:epcglobal:cbv:mda#strengthDescription">100mg</attribute>
        <attribute id="urn:epcglobal:cbv:mda#netContentDescription">500
pills</attribute>
    </VocabularyElement>
</VocabularyElementList>
</Vocabulary>
<Vocabulary type="urn:epcglobal:epcis:vtype:Location">
    <VocabularyElementList>
        <VocabularyElement id="urn:epc:id:sgln:030000.000000.0">
            <attribute id="urn:epcglobal:cbv:mda#name">GS1 Pharma LLC</attribute>
            <attribute id="urn:epcglobal:cbv:mda#streetAddressOne">George
Ave</attribute>
            <attribute id="urn:epcglobal:cbv:mda#streetAddressTwo">Room
378</attribute>
            <attribute id="urn:epcglobal:cbv:mda#city">Washington</attribute>
            <attribute id="urn:epcglobal:cbv:mda#state">DC</attribute>
            <attribute id="urn:epcglobal:cbv:mda#postalCode">12345-
6789</attribute>
            <attribute id="urn:epcglobal:cbv:mda#countryCode">US</attribute>
        </VocabularyElement>
        <VocabularyElement id="urn:epc:id:sgln:0614141.000000.0">
            <attribute id="urn:epcglobal:cbv:mda#name">GS1 Drug Distro
LLC</attribute>
            <attribute id="urn:epcglobal:cbv:mda#streetAddressOne">230 Park Ave
S</attribute>
            <attribute id="urn:epcglobal:cbv:mda#city">New York</attribute>
            <attribute id="urn:epcglobal:cbv:mda#state">NY</attribute>
            <attribute id="urn:epcglobal:cbv:mda#postalCode">10003-
1502</attribute>
            <attribute id="urn:epcglobal:cbv:mda#countryCode">US</attribute>
        </VocabularyElement>
    </VocabularyElementList>
</Vocabulary>
</VocabularyList>
</EPCISMasterData>
</extension>
<gslushc:dscsaTransactionStatement>
    <gslushc:affirmTransactionStatement>true</gslushc:affirmTransactionStatement>
    <gslushc:legalNotice>Seller has complied with each applicable subsection of FDCA Sec.
581 (27) (A) - (G).</gslushc:legalNotice>
</gslushc:dscsaTransactionStatement>
</EPCISHeader>
<EPCISBody>
    <EventList>
        <!-- Transaction Information (TI) -->
        <ObjectEvent>
            <eventTime>2014-04-03T12:13:14Z</eventTime>
            <eventTimeZoneOffset>-05:00</eventTimeZoneOffset>
            <epcList/>
            <action>OBSERVE</action>
            <bizStep>urn:epcglobal:cbv:bizstep:shipping</bizStep>

```

```

<disposition>urn:epcglobal:cbv:disp:in_transit</disposition>
<readPoint>
  <id>urn:epc:id:sgln:030000.000000.0</id>
</readPoint>
<extension>
  <quantityList>
    <quantityElement>
      <epcClass>urn:epc:class:lgtin:030000.0000001.L1</epcClass>
      <quantity>50</quantity>
    </quantityElement>
  </quantityList>
  <sourceList>
    <source
type="urn:epcglobal:cbv:sdt:owning_party">urn:epc:id:sgln:030000.000000.0</source>
    </sourceList>
  <destinationList>
    <destination
type="urn:epcglobal:cbv:sdt:owning_party">urn:epc:id:sgln:0614141.00000.0</destination>
    </destinationList>
  </extension>
</ObjectEvent>
</EventList>
</EPCISBody>
</epcis:EPCISDocument>

```

5.3 Sample XML: W1 → D



Note: The message content of the M → W1 transaction on April 3 in this example is almost identical to the content of the W1 → D transaction in Direct Purchase Examples 1, 2, and 3: only the quantity is different.

Reference File: <https://resources.gs1us.org/Portals/0/xml/LotChoreo-DirectPurchaseExample4-W1toD.xml>

```

<?xml version="1.0" encoding="UTF-8" standalone="yes"?>
<!-- Lot Choreography End to End Examples: Direct Purchase Example4: W1->D -->
<epcis:EPCISDocument xmlns:cbvmda="urn:epcglobal:cbv:mda"
xmlns:sbdh="http://www.unece.org/cefact/namespaces/StandardBusinessDocumentHeader"
xmlns:gs1ushc="http://epcis.gs1us.org/hc/ns" xmlns:epcis="urn:epcglobal:epcis:xsd:1"
schemaVersion="1.2" xsi:schemaLocation="urn:epcglobal:epcis:xsd:1 EPCglobal-epcis-1_2.xsd"
xmlns:xsi="http://www.w3.org/2001/XMLSchema-instance" creationDate="2014-05-30T15:14:27.574-
04:00">
  <EPCISHeader>
    <sbdh:StandardBusinessDocumentHeader>
      <sbdh:HeaderVersion>1.0</sbdh:HeaderVersion>
      <sbdh:Sender>
        <sbdh:Identifier
Authority="SGLN">urn:epc:id:sgln:0614141.00000.0</sbdh:Identifier>
      </sbdh:Sender>
      <sbdh:Receiver>
        <sbdh:Identifier
Authority="SGLN">urn:epc:id:sgln:5012345.00000.0</sbdh:Identifier>
      </sbdh:Receiver>
      <sbdh:DocumentIdentification>
        <sbdh:Standard>EPCglobal</sbdh:Standard>
        <sbdh:TypeVersion>1.0</sbdh:TypeVersion>
        <sbdh:InstanceIdentifier>1234567890</sbdh:InstanceIdentifier>
        <sbdh:Type>Events</sbdh:Type>

```

```

        <sbdh:CreationDateAndTime>2014-05-30T15:14:27.574-04:00</sbdh:CreationDateAndTime>
    </sbdh:DocumentIdentification>
</sbdh:StandardBusinessDocumentHeader>
<extension>
    <EPCISMasterData>
        <VocabularyList>
            <Vocabulary type="urn:epcglobal:epcis:vtype:EPCClass">
                <VocabularyElementList>
                    <VocabularyElement id="urn:epc:idpat:sgtin:030000.0000001.*">
                        <attribute
id="urn:epcglobal:cbv:mda#additionalTradeItemIdentification">0000000001</attribute>
                        <attribute
id="urn:epcglobal:cbv:mda#additionalTradeItemIdentificationTypeCode">FDA_NDC_11</attribute>
                        <attribute
id="urn:epcglobal:cbv:mda#manufacturerOfTradeItemPartyName">GS1 Pharma LLC</attribute>
                        <attribute
id="urn:epcglobal:cbv:mda#regulatedProductName">Epcistra</attribute>
                        <attribute id="urn:epcglobal:cbv:mda#dosageFormType">PILL</attribute>
                        <attribute
id="urn:epcglobal:cbv:mda#strengthDescription">100mg</attribute>
                        <attribute id="urn:epcglobal:cbv:mda#netContentDescription">500
pills</attribute>
                    </VocabularyElement>
                </VocabularyElementList>
            </Vocabulary>
            <Vocabulary type="urn:epcglobal:epcis:vtype:Location">
                <VocabularyElementList>
                    <VocabularyElement id="urn:epc:id:sgln:030000.000000.0">
                        <attribute id="urn:epcglobal:cbv:mda#name">GS1 Pharma LLC</attribute>
                        <attribute id="urn:epcglobal:cbv:mda#streetAddressOne">1295 S George
Ave</attribute>
                        <attribute id="urn:epcglobal:cbv:mda#streetAddressTwo">Room
378</attribute>
                        <attribute id="urn:epcglobal:cbv:mda#city">Washington</attribute>
                        <attribute id="urn:epcglobal:cbv:mda#state">DC</attribute>
                        <attribute id="urn:epcglobal:cbv:mda#postalCode">12345-
6789</attribute>
                        <attribute id="urn:epcglobal:cbv:mda#countryCode">US</attribute>
                    </VocabularyElement>
                    <VocabularyElement id="urn:epc:id:sgln:0614141.00000.0">
                        <attribute id="urn:epcglobal:cbv:mda#name">GS1 Drug Distro
LLC</attribute>
                        <attribute id="urn:epcglobal:cbv:mda#streetAddressOne">230 Park Ave
S</attribute>
                        <attribute id="urn:epcglobal:cbv:mda#city">New York</attribute>
                        <attribute id="urn:epcglobal:cbv:mda#state">NY</attribute>
                        <attribute id="urn:epcglobal:cbv:mda#postalCode">10003-
1502</attribute>
                        <attribute id="urn:epcglobal:cbv:mda#countryCode">US</attribute>
                    </VocabularyElement>
                    <VocabularyElement id="urn:epc:id:sgln:5012345.00000.0">
                        <attribute id="urn:epcglobal:cbv:mda#name">GS1 Pere et Fils
Pharmacy</attribute>
                        <attribute id="urn:epcglobal:cbv:mda#streetAddressOne">1313
Mockingbird Lane</attribute>
                        <attribute id="urn:epcglobal:cbv:mda#city">Paris</attribute>
                        <attribute id="urn:epcglobal:cbv:mda#state">TX</attribute>
                        <attribute id="urn:epcglobal:cbv:mda#postalCode">76543</attribute>
                        <attribute id="urn:epcglobal:cbv:mda#countryCode">US</attribute>
                    </VocabularyElement>
                </VocabularyElementList>
            </Vocabulary>
        </VocabularyList>
    </EPCISMasterData>
</extension>

```

```

        </Vocabulary>
      </VocabularyList>
    </EPCISMasterData>
  </extension>
  <gslushc:dscsaTransactionStatement>
    <gslushc:affirmTransactionStatement>true</gslushc:affirmTransactionStatement>
    <gslushc:legalNotice>Seller has complied with each applicable subsection of FDCA Sec.
581(27)(A)-(G). As indicated below, product was purchased directly from the manufacturer,
manufacturer's exclusive distributor or repackager who purchased directly from a
manufacturer.</gslushc:legalNotice>
  </gslushc:dscsaTransactionStatement>
</EPCISHeader>
<EPCISBody>
  <EventList>
    <!-- Transaction History (TH) -->
    <ObjectEvent>
      <eventTime>1970-01-01T00:00:00.000Z</eventTime>
      <eventTimeZoneOffset>+00:00</eventTimeZoneOffset>
      <epcList/>
      <action>OBSERVE</action>
      <bizStep>urn:epcglobal:cbv:bizstep:shipping</bizStep>
      <disposition>urn:epcglobal:cbv:disp:in_transit</disposition>
      <readPoint>
        <id>urn:epc:id:sgln:030000.000000.0</id>
      </readPoint>
      <extension>
        <quantityList>
          <quantityElement>
            <epcClass>urn:epc:idpat:sgtin:030000.0000001.*</epcClass>
            <quantity>30</quantity>
          </quantityElement>
        </quantityList>
        <sourceList>
          <source
type="urn:epcglobal:cbv:sdt:owning_party">urn:epc:id:sgln:030000.000000.0</source>
        </sourceList>
        <destinationList>
          <destination
type="urn:epcglobal:cbv:sdt:owning_party">urn:epc:id:sgln:0614141.00000.0</destination>
        </destinationList>
      </extension>
    </ObjectEvent>
    <!-- Transaction Information (TI) -->
    <ObjectEvent>
      <eventTime>2014-04-05T11:00:00.000-04:00</eventTime>
      <eventTimeZoneOffset>-04:00</eventTimeZoneOffset>
      <epcList/>
      <action>OBSERVE</action>
      <bizStep>urn:epcglobal:cbv:bizstep:shipping</bizStep>
      <disposition>urn:epcglobal:cbv:disp:in_transit</disposition>
      <readPoint>
        <id>urn:epc:id:sgln:0614141.00000.0</id>
      </readPoint>
      <extension>
        <quantityList>
          <quantityElement>
            <epcClass>urn:epc:idpat:sgtin:030000.0000001.*</epcClass>
            <quantity>30</quantity>
          </quantityElement>
        </quantityList>
        <sourceList>

```

```
        <source
type="urn:epcglobal:cbv:sdt:owning_party">urn:epc:id:sgln:0614141.00000.0</source>
        </sourceList>
        <destinationList>
        <destination
type="urn:epcglobal:cbv:sdt:owning_party">urn:epc:id:sgln:5012345.00000.0</destination>
        </destinationList>
        </extension>
        <gslushc:directPurchase value="true"/>
    </ObjectEvent>
</EventList>
</EPCISBody>
</epcis:EPCISDocument>
```

6 Extended Supply Chain Scenario – Example 1

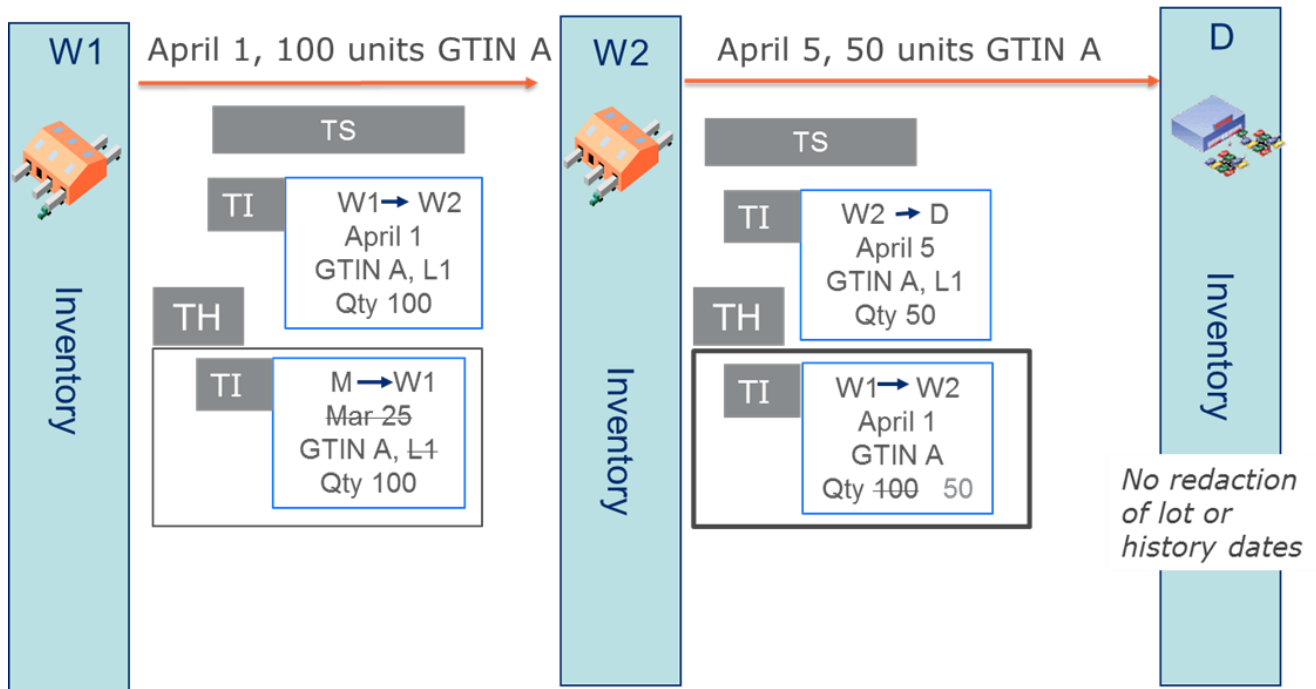

6.1 Sample XML: W1 → W2

Reference File: <https://resources.gs1us.org/Portals/0/xml/LotChoreo-ExtendedSupplyChainExample1-W1toW2.xml>

```
<?xml version="1.0" encoding="UTF-8" standalone="yes"?>
<!-- Lot Choreography End to End Examples: EXTENDED SUPPLY CHAIN - EXAMPLE 1: W1->W2-->
<epcis:EPCISDocument xmlns:cbvmda="urn:epcglobal:cbv:mda"
xmlns:sbdh="http://www.unece.org/cefact/namespaces/StandardBusinessDocumentHeader"
xmlns:gslushc="http://epcis.gs1us.org/hc/ns" xmlns:epcis="urn:epcglobal:epcis:xsd:1"
schemaVersion="1.2" xsi:schemaLocation="urn:epcglobal:epcis:xsd:1 EPCglobal-epcis-1_2.xsd"
xmlns:xsi="http://www.w3.org/2001/XMLSchema-instance" creationDate="2014-05-30T15:14:27.574-
04:00">
  <EPCISHeader>
    <sbdh:StandardBusinessDocumentHeader>
      <sbdh:HeaderVersion>1.0</sbdh:HeaderVersion>
      <sbdh:Sender>
        <sbdh:Identifier
Authority="SGLN">urn:epc:id:sgln:0614141.00000.0</sbdh:Identifier>
      </sbdh:Sender>
      <sbdh:Receiver>
        <sbdh:Identifier
Authority="SGLN">urn:epc:id:sgln:9508888.00000.0</sbdh:Identifier>
      </sbdh:Receiver>
      <sbdh:DocumentIdentification>
        <sbdh:Standard>EPCglobal</sbdh:Standard>
        <sbdh:TypeVersion>1.0</sbdh:TypeVersion>
        <sbdh:InstanceIdentifier>1234567890</sbdh:InstanceIdentifier>
        <sbdh:Type>Events</sbdh:Type>
        <sbdh:CreationDateAndTime>2014-05-30T15:14:27.574-04:00</sbdh:CreationDateAndTime>
      </sbdh:DocumentIdentification>
    </sbdh:StandardBusinessDocumentHeader>
    <extension>
      <EPCISMasterData>
        <VocabularyList>
          <Vocabulary type="urn:epcglobal:epcis:vtype:EPCClass">
            <VocabularyElementList>
              <VocabularyElement id="urn:epc:idpat:sgtin:030000.0000001.*">
                <attribute
id="urn:epcglobal:cbv:mda#additionalTradeItemIdentification">00000000001</attribute>
                <attribute
id="urn:epcglobal:cbv:mda#additionalTradeItemIdentificationTypeCode">FDA_NDC_11</attribute>
                <attribute
id="urn:epcglobal:cbv:mda#manufacturerOfTradeItemPartyName">GS1 Pharma LLC</attribute>
                <attribute
id="urn:epcglobal:cbv:mda#regulatedProductName">Epcistra</attribute>
                <attribute id="urn:epcglobal:cbv:mda#dosageFormType">PILL</attribute>
                <attribute
id="urn:epcglobal:cbv:mda#strengthDescription">100mg</attribute>
                <attribute id="urn:epcglobal:cbv:mda#netContentDescription">500
pills</attribute>
              </VocabularyElement>
            </VocabularyElementList>
          </Vocabulary>
          <Vocabulary type="urn:epcglobal:epcis:vtype:Location">
            <VocabularyElementList>
              <VocabularyElement id="urn:epc:id:sgln:030000.000000.0">
                <attribute id="urn:epcglobal:cbv:mda#name">GS1 Pharma LLC</attribute>
                <attribute id="urn:epcglobal:cbv:mda#streetAddressOne">1295 S George
Ave</attribute>
```



```

        <attribute id="urn:epcglobal:cbv:mda#streetAddressTwo">Room
378</attribute>
        <attribute id="urn:epcglobal:cbv:mda#city">Washington</attribute>
        <attribute id="urn:epcglobal:cbv:mda#state">DC</attribute>
        <attribute id="urn:epcglobal:cbv:mda#postalCode">12345-
6789</attribute>
        <attribute id="urn:epcglobal:cbv:mda#countryCode">US</attribute>
</VocabularyElement>
<VocabularyElement id="urn:epc:id:sgln:0614141.00000.0">
    <attribute id="urn:epcglobal:cbv:mda#name">GS1 Drug Distro
LLC</attribute>
    <attribute id="urn:epcglobal:cbv:mda#streetAddressOne">230 Park Ave
S</attribute>
    <attribute id="urn:epcglobal:cbv:mda#city">New York</attribute>
    <attribute id="urn:epcglobal:cbv:mda#state">NY</attribute>
    <attribute id="urn:epcglobal:cbv:mda#postalCode">10003-
1502</attribute>
    <attribute id="urn:epcglobal:cbv:mda#countryCode">US</attribute>
</VocabularyElement>
<VocabularyElement id="urn:epc:id:sgln:9508888.00000.0">
    <attribute id="urn:epcglobal:cbv:mda#name">GS1 Cayman Islands
Wholesale</attribute>
    <attribute id="urn:epcglobal:cbv:mda#streetAddressOne">1 Shamrock
Road</attribute>
    <attribute id="urn:epcglobal:cbv:mda#city">Bodden Town</attribute>
    <attribute id="urn:epcglobal:cbv:mda#countryCode">KY</attribute>
</VocabularyElement>
</VocabularyElementList>
</Vocabulary>
</VocabularyList>
</EPCISMasterData>
</extension>
<gslushc:dscsaTransactionStatement>
    <gslushc:affirmTransactionStatement>true</gslushc:affirmTransactionStatement>
    <gslushc:legalNotice>Seller has complied with each applicable subsection of FDCA Sec.
581(27)(A)-(G). As indicated below, product was purchased directly from the manufacturer,
manufacturer's exclusive distributor or repackager who purchased directly from a
manufacturer.</gslushc:legalNotice>
</gslushc:dscsaTransactionStatement>
</EPCISHeader>
<EPCISBody>
    <EventList>
        <!-- Transaction History (TH) -->
        <ObjectEvent>
            <eventTime>1970-01-01T00:00:00.000Z</eventTime>
            <eventTimeZoneOffset>+00:00</eventTimeZoneOffset>
            <epcList/>
            <action>OBSERVE</action>
            <bizStep>urn:epcglobal:cbv:bizstep:shipping</bizStep>
            <disposition>urn:epcglobal:cbv:disp:in_transit</disposition>
            <readPoint>
                <id>urn:epc:id:sgln:030000.000000.0</id>
            </readPoint>
            <extension>
                <quantityList>
                    <quantityElement>
                        <epcClass>urn:epc:idpat:sgtin:030000.0000001.*</epcClass>
                        <quantity>100</quantity>
                    </quantityElement>
                </quantityList>
                <sourceList>

```

```

                <source
type="urn:epcglobal:cbv:sdt:owning_party">urn:epc:id:sgln:030000.000000.0</source>
                </sourceList>
                <destinationList>
                <destination
type="urn:epcglobal:cbv:sdt:owning_party">urn:epc:id:sgln:0614141.00000.0</destination>
                </destinationList>
                </extension>
</ObjectEvent>
<!-- Transaction Information (TI) -->
<ObjectEvent>
    <eventTime>2014-04-01T11:00:00.000-04:00</eventTime>
    <eventTimeZoneOffset>-04:00</eventTimeZoneOffset>
    <epcList/>
    <action>OBSERVE</action>
    <bizStep>urn:epcglobal:cbv:bizstep:shipping</bizStep>
    <disposition>urn:epcglobal:cbv:disp:in_transit</disposition>
    <readPoint>
        <id>urn:epc:id:sgln:0614141.00000.0</id>
    </readPoint>
    <extension>
        <quantityList>
            <quantityElement>
                <epcClass>urn:epc:idpat:sgtin:030000.0000001.*</epcClass>
                <quantity>100</quantity>
            </quantityElement>
        </quantityList>
        <sourceList>
            <source
type="urn:epcglobal:cbv:sdt:owning_party">urn:epc:id:sgln:0614141.00000.0</source>
            </sourceList>
            <destinationList>
            <destination
type="urn:epcglobal:cbv:sdt:owning_party">urn:epc:id:sgln:9508888.00000.0</destination>
            </destinationList>
        </extension>
        <gslushc:directPurchase value="true"/>
    </ObjectEvent>
</EventList>
</EPCISBody>
</epcis:EPCISDocument>

```

6.2 Sample XML: W2 → D

Reference File: <https://resources.gs1us.org/Portals/0/xml/LotChoreo-ExtendedSupplyChainExample1-W2toD.xml>

```

<?xml version="1.0" encoding="UTF-8" standalone="yes"?>
<!-- Lot Choreography End to End Examples: EXTENDED SUPPLY CHAIN - EXAMPLE 1: W2->D-->
<epcis:EPCISDocument xmlns:cbvmda="urn:epcglobal:cbv:mda"
xmlns:sbdh="http://www.unece.org/cefact/namespaces/StandardBusinessDocumentHeader"
xmlns:gslushc="http://epcis.gs1us.org/hc/ns" xmlns:epcis="urn:epcglobal:epcis:xsd:1"
schemaVersion="1.2" xsi:schemaLocation="urn:epcglobal:epcis:xsd:1 EPCglobal-epcis-1_2.xsd"
xmlns:xsi="http://www.w3.org/2001/XMLSchema-instance" creationDate="2014-05-30T15:14:27.574-
04:00">
    <EPCISHeader>
        <sbdh:StandardBusinessDocumentHeader>
            <sbdh:HeaderVersion>1.0</sbdh:HeaderVersion>
            <sbdh:Sender>

```

```

        <sbdh:Identifier
Authority="SGLN">urn:epc:id:sgln:9508888.00000.0</sbdh:Identifier>
        </sbdh:Sender>
        <sbdh:Receiver>
        <sbdh:Identifier
Authority="SGLN">urn:epc:id:sgln:5012345.00000.0</sbdh:Identifier>
        </sbdh:Receiver>
        <sbdh:DocumentIdentification>
        <sbdh:Standard>EPCglobal</sbdh:Standard>
        <sbdh:TypeVersion>1.0</sbdh:TypeVersion>
        <sbdh:InstanceIdentifier>1234567890</sbdh:InstanceIdentifier>
        <sbdh:Type>Events</sbdh:Type>
        <sbdh:CreationDateAndTime>2014-05-30T15:14:27.574-04:00</sbdh:CreationDateAndTime>
        </sbdh:DocumentIdentification>
    </sbdh:StandardBusinessDocumentHeader>
    <extension>
        <EPCISMasterData>
            <VocabularyList>
                <Vocabulary type="urn:epcglobal:epcis:vtype:EPCClass">
                    <VocabularyElementList>
                        <VocabularyElement id="urn:epc:idpat:sgtin:030000.0000001.*">
                            <attribute
id="urn:epcglobal:cbv:mda#additionalTradeItemIdentification">00000000001</attribute>
                            <attribute
id="urn:epcglobal:cbv:mda#additionalTradeItemIdentificationTypeCode">FDA_NDC_11</attribute>
                            <attribute
id="urn:epcglobal:cbv:mda#manufacturerOfTradeItemPartyName">GS1 Pharma LLC</attribute>
                            <attribute
id="urn:epcglobal:cbv:mda#regulatedProductName">Epcistra</attribute>
                            <attribute id="urn:epcglobal:cbv:mda#dosageFormType">PILL</attribute>
                            <attribute
id="urn:epcglobal:cbv:mda#strengthDescription">100mg</attribute>
                            <attribute id="urn:epcglobal:cbv:mda#netContentDescription">500
pills</attribute>
                        </VocabularyElement>
                    </VocabularyElementList>
                </Vocabulary>
                <Vocabulary type="urn:epcglobal:epcis:vtype:Location">
                    <VocabularyElementList>
                        <VocabularyElement id="urn:epc:id:sgln:0614141.00000.0">
                            <attribute id="urn:epcglobal:cbv:mda#name">GS1 Drug Distro
LLC</attribute>
                            <attribute id="urn:epcglobal:cbv:mda#streetAddressOne">230 Park Ave
S</attribute>
                            <attribute id="urn:epcglobal:cbv:mda#city">New York</attribute>
                            <attribute id="urn:epcglobal:cbv:mda#state">NY</attribute>
                            <attribute id="urn:epcglobal:cbv:mda#postalCode">10003-
1502</attribute>
                            <attribute id="urn:epcglobal:cbv:mda#countryCode">US</attribute>
                        </VocabularyElement>
                    <VocabularyElement id="urn:epc:id:sgln:9508888.00000.0">
                            <attribute id="urn:epcglobal:cbv:mda#name">GS1 Cayman Islands
Wholesale</attribute>
                            <attribute id="urn:epcglobal:cbv:mda#streetAddressOne">1 Shamrock
Road</attribute>
                            <attribute id="urn:epcglobal:cbv:mda#city">Bodden Town</attribute>
                            <attribute id="urn:epcglobal:cbv:mda#countryCode">KY</attribute>
                        </VocabularyElement>
                    <VocabularyElement id="urn:epc:id:sgln:5012345.00000.0">
                            <attribute id="urn:epcglobal:cbv:mda#name">GS1 Pere et Fils
Pharmacy</attribute>
                </VocabularyList>
            </EPCISMasterData>
        </extension>
    </sbdh:StandardBusinessDocumentHeader>

```

```

        <attribute id="urn:epcglobal:cbv:mda#streetAddressOne">1313
Mockingbird Lane</attribute>
        <attribute id="urn:epcglobal:cbv:mda#city">Paris</attribute>
        <attribute id="urn:epcglobal:cbv:mda#state">TX</attribute>
        <attribute id="urn:epcglobal:cbv:mda#postalCode">76543</attribute>
        <attribute id="urn:epcglobal:cbv:mda#countryCode">US</attribute>
    </VocabularyElement>
</VocabularyElementList>
</Vocabulary>
</VocabularyList>
</EPCISMasterData>
</extension>
<gslushc:dscsaTransactionStatement>
    <gslushc:affirmTransactionStatement>true</gslushc:affirmTransactionStatement>
    <gslushc:legalNotice>Seller has complied with each applicable subsection of FDCA Sec.
581(27)(A)-(G). As indicated below, product was purchased directly from the manufacturer,
manufacturer's exclusive distributor or repackager who purchased directly from a
manufacturer.</gslushc:legalNotice>
</gslushc:dscsaTransactionStatement>
</EPCISHeader>
<EPCISBody>
    <EventList>
        <!-- Transaction History (TH) -->
        <ObjectEvent>
            <eventTime>2014-04-01T11:00:00.000-04:00</eventTime>
            <eventTimeZoneOffset>-04:00</eventTimeZoneOffset>
            <epcList/>
            <action>OBSERVE</action>
            <bizStep>urn:epcglobal:cbv:bizstep:shipping</bizStep>
            <disposition>urn:epcglobal:cbv:disp:in_transit</disposition>
            <readPoint>
                <id>urn:epc:id:sgln:0614141.00000.0</id>
            </readPoint>
            <extension>
                <quantityList>
                    <quantityElement>
                        <!-- Since Lot is redacted from the TH sent by W1->W2,
W2 captures the Lot# from the physical product in order to
include Lot information in TH sent to D -->
                        <epcClass>urn:epc:class:lgtn:030000.0000001.L1</epcClass>
                        <quantity>50</quantity>
                    </quantityElement>
                </quantityList>
                <sourceList>
                    <source
type="urn:epcglobal:cbv:sdt:owning_party">urn:epc:id:sgln:0614141.00000.0</source>
                    </sourceList>
                <destinationList>
                    <destination
type="urn:epcglobal:cbv:sdt:owning_party">urn:epc:id:sgln:9508888.00000.0</destination>
                    </destinationList>
                </extension>
            </ObjectEvent>
        <!-- Transaction Information (TI) -->
        <ObjectEvent>
            <eventTime>2014-04-05T11:00:00.000-04:00</eventTime>
            <eventTimeZoneOffset>-04:00</eventTimeZoneOffset>
            <epcList/>
            <action>OBSERVE</action>
            <bizStep>urn:epcglobal:cbv:bizstep:shipping</bizStep>
            <disposition>urn:epcglobal:cbv:disp:in_transit</disposition>

```

```
<readPoint>
  <id>urn:epc:id:sgln:9508888.00000.0</id>
</readPoint>
<extension>
  <quantityList>
    <quantityElement>
      <!-- Since Lot is redacted from the TH sent by W1->W2,
           W2 captures the Lot# from the physical product in order to
include Lot information in TI sent to D -->
      <epcClass>urn:epc:class:lgtn:030000.0000001.L1</epcClass>
      <quantity>50</quantity>
    </quantityElement>
  </quantityList>
  <sourceList>
    <source
type="urn:epcglobal:cbv:sdt:owning_party">urn:epc:id:sgln:9508888.00000.0</source>
    </sourceList>
    <destinationList>
      <destination
type="urn:epcglobal:cbv:sdt:owning_party">urn:epc:id:sgln:5012345.00000.0</destination>
    </destinationList>
  </extension>

  <gslushc:receivedADirectPurchaseStatementFromPreviousWholesaleDistributor>true</gslushc:rece
ivedADirectPurchaseStatementFromPreviousWholesaleDistributor>
  </ObjectEvent>
</EventList>
</EPCISBody>
</epcis:EPCISDocument>
```

7 Extended Supply Chain Scenario – Example 2

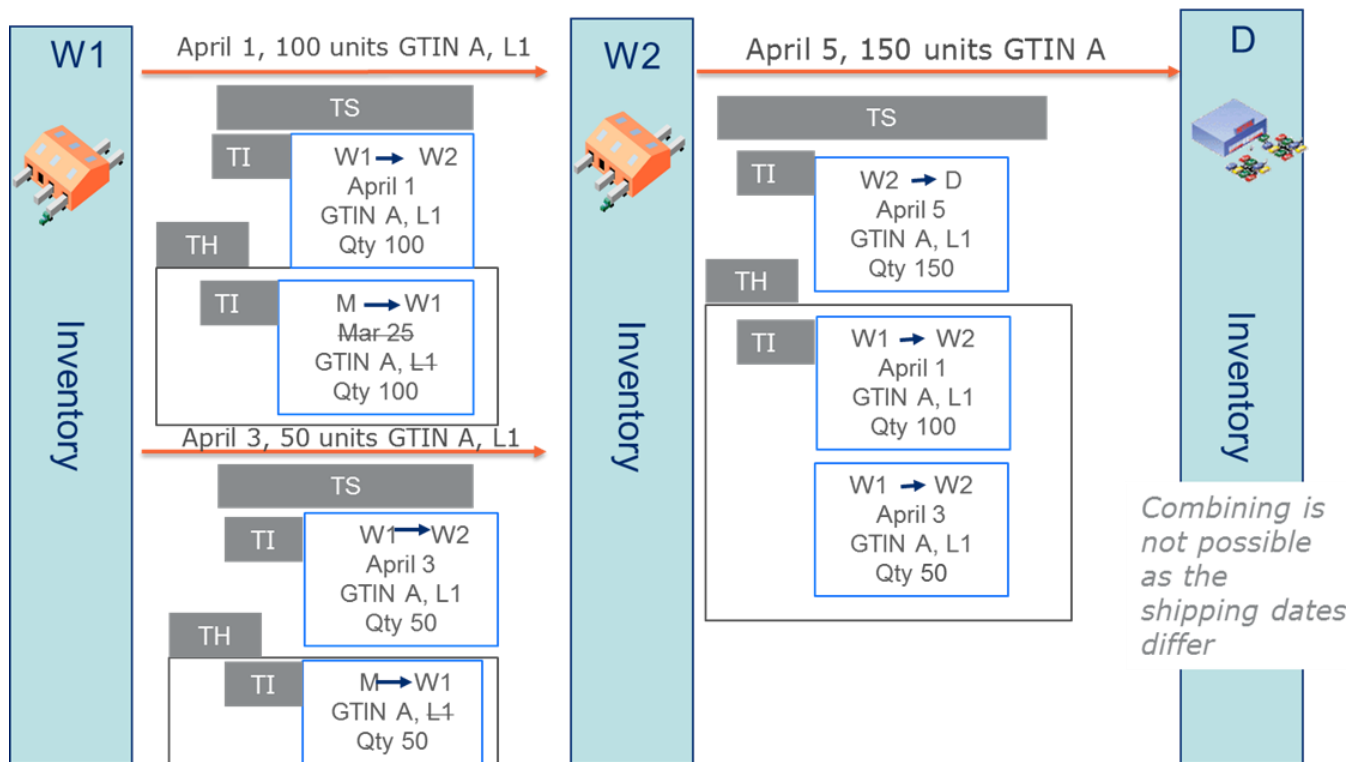

7.1 Sample XML: W1 → W2, April 1

 **Note:** The message content of the W1 → W2 transaction on April 1 in this example is identical to the content of the W1 → W2 transaction in [Extended Supply Chain Example 1](#).

Reference File: <https://resources.gs1us.org/Portals/0/xml/LotChoreo-ExtendedSupplyChainExample2-W1toW2Apr1.xml>

```
<?xml version="1.0" encoding="UTF-8" standalone="yes"?>
<!-- Lot Choreography End to End Examples: EXTENDED SUPPLY CHAIN - EXAMPLE 2: W1->W2, April 1 -
-->
<!-- The W1->W2 transaction on April 1 in this example is identical to the content in W1->W2
transaction in Extended Supply Chain Example 1 -->
<epcis:EPCISDocument xmlns:cbvmda="urn:epcglobal:cbv:mda"
xmlns:sbdh="http://www.unece.org/cefact/namespaces/StandardBusinessDocumentHeader"
xmlns:gslushc="http://epcis.gs1us.org/hc/ns" xmlns:epcis="urn:epcglobal:epcis:xsd:1"
schemaVersion="1.2" xsi:schemaLocation="urn:epcglobal:epcis:xsd:1 EPCglobal-epcis-1_2.xsd"
xmlns:xsi="http://www.w3.org/2001/XMLSchema-instance" creationDate="2014-05-30T15:14:27.574-
04:00">
  <EPCISHeader>
    <sbdh:StandardBusinessDocumentHeader>
      <sbdh:HeaderVersion>1.0</sbdh:HeaderVersion>
      <sbdh:Sender>
        <sbdh:Identifier
Authority="SGLN">urn:epc:id:sgln:0614141.00000.0</sbdh:Identifier>
        </sbdh:Sender>
      <sbdh:Receiver>
        <sbdh:Identifier
Authority="SGLN">urn:epc:id:sgln:9508888.00000.0</sbdh:Identifier>
        </sbdh:Receiver>
      <sbdh:DocumentIdentification>
        <sbdh:Standard>EPCglobal</sbdh:Standard>
        <sbdh:TypeVersion>1.0</sbdh:TypeVersion>
        <sbdh:InstanceIdentifier>1234567890</sbdh:InstanceIdentifier>
        <sbdh:Type>Events</sbdh:Type>
        <sbdh:CreationDateAndTime>2014-05-30T15:14:27.574-04:00</sbdh:CreationDateAndTime>
      </sbdh:DocumentIdentification>
    </sbdh:StandardBusinessDocumentHeader>
    <extension>
      <EPCISMasterData>
        <VocabularyList>
          <Vocabulary type="urn:epcglobal:epcis:vtype:EPCClass">
            <VocabularyElementList>
              <VocabularyElement id="urn:epc:idpat:sgtin:030000.0000001.*">
                <attribute
id="urn:epcglobal:cbv:mda#additionalTradeItemIdentification">00000000001</attribute>
                <attribute
id="urn:epcglobal:cbv:mda#additionalTradeItemIdentificationTypeCode">FDA_NDC_11</attribute>
                <attribute
id="urn:epcglobal:cbv:mda#manufacturerOfTradeItemPartyName">GS1 Pharma LLC</attribute>
                <attribute
id="urn:epcglobal:cbv:mda#regulatedProductName">Epcistra</attribute>
                <attribute id="urn:epcglobal:cbv:mda#dosageFormType">PILL</attribute>
                <attribute
id="urn:epcglobal:cbv:mda#strengthDescription">100mg</attribute>
                <attribute id="urn:epcglobal:cbv:mda#netContentDescription">500
pills</attribute>
              </VocabularyElement>
            </VocabularyElementList>
          </Vocabulary>
        </VocabularyList>
      </EPCISMasterData>
    </extension>
  </EPCISDocument>

```

```

</Vocabulary>
<Vocabulary type="urn:epcglobal:epcis:vtype:Location">
  <VocabularyElementList>
    <VocabularyElement id="urn:epc:id:sgln:030000.000000.0">
      <attribute id="urn:epcglobal:cbv:mda#name">GS1 Pharma LLC</attribute>
      <attribute id="urn:epcglobal:cbv:mda#streetAddressOne">1295 S George
Ave</attribute>
      <attribute id="urn:epcglobal:cbv:mda#streetAddressTwo">Room
378</attribute>
      <attribute id="urn:epcglobal:cbv:mda#city">Washington</attribute>
      <attribute id="urn:epcglobal:cbv:mda#state">DC</attribute>
      <attribute id="urn:epcglobal:cbv:mda#postalCode">12345-
6789</attribute>
      <attribute id="urn:epcglobal:cbv:mda#countryCode">US</attribute>
    </VocabularyElement>
    <VocabularyElement id="urn:epc:id:sgln:0614141.000000.0">
      <attribute id="urn:epcglobal:cbv:mda#name">GS1 Drug Distro
LLC</attribute>
      <attribute id="urn:epcglobal:cbv:mda#streetAddressOne">230 Park Ave
S</attribute>
      <attribute id="urn:epcglobal:cbv:mda#city">New York</attribute>
      <attribute id="urn:epcglobal:cbv:mda#state">NY</attribute>
      <attribute id="urn:epcglobal:cbv:mda#postalCode">10003-
1502</attribute>
      <attribute id="urn:epcglobal:cbv:mda#countryCode">US</attribute>
    </VocabularyElement>
    <VocabularyElement id="urn:epc:id:sgln:9508888.000000.0">
      <attribute id="urn:epcglobal:cbv:mda#name">GS1 Cayman Islands
Wholesale</attribute>
      <attribute id="urn:epcglobal:cbv:mda#streetAddressOne">1 Shamrock
Road</attribute>
      <attribute id="urn:epcglobal:cbv:mda#city">Bodden Town</attribute>
      <attribute id="urn:epcglobal:cbv:mda#countryCode">KY</attribute>
    </VocabularyElement>
  </VocabularyElementList>
</Vocabulary>
</VocabularyList>
</EPCISMasterData>
</extension>
<gslushc:dscsaTransactionStatement>
  <gslushc:affirmTransactionStatement>true</gslushc:affirmTransactionStatement>
  <gslushc:legalNotice>Seller has complied with each applicable subsection of FDCA Sec.
581(27)(A)-(G). As indicated below, product was purchased directly from the manufacturer,
manufacturer's exclusive distributor or repackager who purchased directly from a
manufacturer.</gslushc:legalNotice>
</gslushc:dscsaTransactionStatement>
</EPCISHeader>
<EPCISBody>
  <EventList>
    <!-- Transaction History (TH) -->
    <ObjectEvent>
      <eventTime>1970-01-01T00:00:00.000Z</eventTime>
      <eventTimeZoneOffset>+00:00</eventTimeZoneOffset>
      <epcList/>
      <action>OBSERVE</action>
      <bizStep>urn:epcglobal:cbv:bizstep:shipping</bizStep>
      <disposition>urn:epcglobal:cbv:disp:in_transit</disposition>
      <readPoint>
        <id>urn:epc:id:sgln:030000.000000.0</id>
      </readPoint>
      <extension>

```



```

    <quantityList>
      <quantityElement>
        <epcClass>urn:epc:idpat:sgtin:030000.0000001.*</epcClass>
        <quantity>100</quantity>
      </quantityElement>
    </quantityList>
    <sourceList>
      <source
type="urn:epcglobal:cbv:sdt:owning_party">urn:epc:id:sgln:030000.000000.0</source>
    </sourceList>
    <destinationList>
      <destination
type="urn:epcglobal:cbv:sdt:owning_party">urn:epc:id:sgln:0614141.00000.0</destination>
    </destinationList>
  </extension>
</ObjectEvent>
<!-- Transaction Information (TI) -->
<ObjectEvent>
  <eventTime>2014-04-01T11:00:00.000-04:00</eventTime>
  <eventTimeZoneOffset>-04:00</eventTimeZoneOffset>
  <epcList/>
  <action>OBSERVE</action>
  <bizStep>urn:epcglobal:cbv:bizstep:shipping</bizStep>
  <disposition>urn:epcglobal:cbv:disp:in_transit</disposition>
  <readPoint>
    <id>urn:epc:id:sgln:0614141.00000.0</id>
  </readPoint>
  <extension>
    <quantityList>
      <quantityElement>
        <epcClass>urn:epc:idpat:sgtin:030000.0000001.*</epcClass>
        <quantity>100</quantity>
      </quantityElement>
    </quantityList>
    <sourceList>
      <source
type="urn:epcglobal:cbv:sdt:owning_party">urn:epc:id:sgln:0614141.00000.0</source>
    </sourceList>
    <destinationList>
      <destination
type="urn:epcglobal:cbv:sdt:owning_party">urn:epc:id:sgln:9508888.00000.0</destination>
    </destinationList>
  </extension>
  <gslushc:directPurchase value="true"/>
</ObjectEvent>
</EventList>
</EPCISBody>
</epcis:EPCISDocument>

```

7.2 Sample XML: W1 → W2, April 3

Reference File: https://resources.gs1us.org/Portals/0/xml/LotChoreo-ExtendedSupplyChainExample2-W1toW2_Apr3.xml

```

<?xml version="1.0" encoding="UTF-8" standalone="yes"?>
<!-- Lot Choreography End to End Examples: EXTENDED SUPPLY CHAIN - EXAMPLE 2: W1->W2, April 3 -->
<epcis:EPCISDocument xmlns:cbvmda="urn:epcglobal:cbv:mda"
xmlns:sbdh="http://www.unece.org/cefact/namespaces/StandardBusinessDocumentHeader"
xmlns:gslushc="http://epcis.gslus.org/hc/ns" xmlns:epcis="urn:epcglobal:epcis:xsd:1"

```

```

schemaVersion="1.2" xsi:schemaLocation="urn:epcglobal:epcis:xsd:1 EPCglobal-epcis-1_2.xsd"
xmlns:xsi="http://www.w3.org/2001/XMLSchema-instance" creationDate="2014-05-30T15:14:27.574-
04:00">
  <EPCISHeader>
    <sbdh:StandardBusinessDocumentHeader>
      <sbdh:HeaderVersion>1.0</sbdh:HeaderVersion>
      <sbdh:Sender>
        <sbdh:Identifier
Authority="SGLN">urn:epc:id:sgln:0614141.00000.0</sbdh:Identifier>
      </sbdh:Sender>
      <sbdh:Receiver>
        <sbdh:Identifier
Authority="SGLN">urn:epc:id:sgln:9508888.00000.0</sbdh:Identifier>
      </sbdh:Receiver>
      <sbdh:DocumentIdentification>
        <sbdh:Standard>EPCglobal</sbdh:Standard>
        <sbdh:TypeVersion>1.0</sbdh:TypeVersion>
        <sbdh:InstanceIdentifier>1234567890</sbdh:InstanceIdentifier>
        <sbdh:Type>Events</sbdh:Type>
        <sbdh:CreationDateAndTime>2014-05-30T15:14:27.574-04:00</sbdh:CreationDateAndTime>
      </sbdh:DocumentIdentification>
    </sbdh:StandardBusinessDocumentHeader>
    <extension>
      <EPCISMasterData>
        <VocabularyList>
          <Vocabulary type="urn:epcglobal:epcis:vtype:EPCClass">
            <VocabularyElementList>
              <VocabularyElement id="urn:epc:idpat:sgtin:030000.0000001.*">
                <attribute
id="urn:epcglobal:cbv:mda#additionalTradeItemIdentification">00000000001</attribute>
                <attribute
id="urn:epcglobal:cbv:mda#additionalTradeItemIdentificationTypeCode">FDA_NDC_11</attribute>
                <attribute
id="urn:epcglobal:cbv:mda#manufacturerOfTradeItemPartyName">GS1 Pharma LLC</attribute>
                <attribute
id="urn:epcglobal:cbv:mda#regulatedProductName">Epcistra</attribute>
                <attribute id="urn:epcglobal:cbv:mda#dosageFormType">PILL</attribute>
                <attribute
id="urn:epcglobal:cbv:mda#strengthDescription">100mg</attribute>
                <attribute id="urn:epcglobal:cbv:mda#netContentDescription">500
pills</attribute>
              </VocabularyElement>
            </VocabularyElementList>
          </Vocabulary>
          <Vocabulary type="urn:epcglobal:epcis:vtype:Location">
            <VocabularyElementList>
              <VocabularyElement id="urn:epc:id:sgln:030000.000000.0">
                <attribute id="urn:epcglobal:cbv:mda#name">GS1 Pharma LLC</attribute>
                <attribute id="urn:epcglobal:cbv:mda#streetAddressOne">1295 S George
Ave</attribute>
                <attribute id="urn:epcglobal:cbv:mda#streetAddressTwo">Room
378</attribute>
                <attribute id="urn:epcglobal:cbv:mda#city">Washington</attribute>
                <attribute id="urn:epcglobal:cbv:mda#state">DC</attribute>
                <attribute id="urn:epcglobal:cbv:mda#postalCode">12345-
6789</attribute>
                <attribute id="urn:epcglobal:cbv:mda#countryCode">US</attribute>
              </VocabularyElement>
            <VocabularyElement id="urn:epc:id:sgln:0614141.00000.0">
                <attribute id="urn:epcglobal:cbv:mda#name">GS1 Drug Distro
LLC</attribute>

```

```

        <attribute id="urn:epcglobal:cbv:mda#streetAddressOne">230 Park Ave
S</attribute>
        <attribute id="urn:epcglobal:cbv:mda#city">New York</attribute>
        <attribute id="urn:epcglobal:cbv:mda#state">NY</attribute>
        <attribute id="urn:epcglobal:cbv:mda#postalCode">10003-
1502</attribute>
        <attribute id="urn:epcglobal:cbv:mda#countryCode">US</attribute>
</VocabularyElement>
<VocabularyElement id="urn:epc:id:sgln:9508888.00000.0">
  <attribute id="urn:epcglobal:cbv:mda#name">GS1 Cayman Islands
Wholesale</attribute>
  <attribute id="urn:epcglobal:cbv:mda#streetAddressOne">1 Shamrock
Road</attribute>
  <attribute id="urn:epcglobal:cbv:mda#city">Bodden Town</attribute>
  <attribute id="urn:epcglobal:cbv:mda#countryCode">KY</attribute>
</VocabularyElement>
</VocabularyElementList>
</Vocabulary>
</VocabularyList>
</EPCISMasterData>
</extension>
<gslushc:dscsaTransactionStatement>
  <gslushc:affirmTransactionStatement>true</gslushc:affirmTransactionStatement>
  <gslushc:legalNotice>Seller has complied with each applicable subsection of FDCA Sec.
581(27) (A)-(G). As indicated below, product was purchased directly from the manufacturer,
manufacturer's exclusive distributor or repackager who purchased directly from a
manufacturer.</gslushc:legalNotice>
  </gslushc:dscsaTransactionStatement>
</EPCISHeader>
<EPCISBody>
  <EventList>
    <!-- Transaction History (TH) -->
    <ObjectEvent>
      <eventTime>1970-01-01T00:00:00.000Z</eventTime>
      <eventTimeZoneOffset>+00:00</eventTimeZoneOffset>
      <epcList/>
      <action>OBSERVE</action>
      <bizStep>urn:epcglobal:cbv:bizstep:shipping</bizStep>
      <disposition>urn:epcglobal:cbv:disp:in_transit</disposition>
      <readPoint>
        <id>urn:epc:id:sgln:030000.000000.0</id>
      </readPoint>
      <extension>
        <quantityList>
          <quantityElement>
            <epcClass>urn:epc:idpat:sgtin:030000.0000001.*</epcClass>
            <quantity>50</quantity>
          </quantityElement>
        </quantityList>
        <sourceList>
          <source
type="urn:epcglobal:cbv:sdt:owning_party">urn:epc:id:sgln:030000.000000.0</source>
          </sourceList>
        <destinationList>
          <destination
type="urn:epcglobal:cbv:sdt:owning_party">urn:epc:id:sgln:0614141.00000.0</destination>
          </destinationList>
        </extension>
      </ObjectEvent>
    <!-- Transaction Information (TI) -->
    <ObjectEvent>

```

```

<eventTime>2014-04-03T11:00:00.000-04:00</eventTime>
<eventTimeZoneOffset>-04:00</eventTimeZoneOffset>
<epcList/>
<action>OBSERVE</action>
<bizStep>urn:epcglobal:cbv:bizstep:shipping</bizStep>
<disposition>urn:epcglobal:cbv:disp:in_transit</disposition>
<readPoint>
  <id>urn:epc:id:sgln:0614141.00000.0</id>
</readPoint>
<extension>
  <quantityList>
    <quantityElement>
      <epcClass>urn:epc:idpat:sgtin:030000.0000001.*</epcClass>
      <quantity>50</quantity>
    </quantityElement>
  </quantityList>
  <sourceList>
    <source
type="urn:epcglobal:cbv:sdt:owning_party">urn:epc:id:sgln:0614141.00000.0</source>
    </sourceList>
    <destinationList>
      <destination
type="urn:epcglobal:cbv:sdt:owning_party">urn:epc:id:sgln:9508888.00000.0</destination>
    </destinationList>
  </extension>
  <gslushc:directPurchase value="true"/>
</ObjectEvent>
</EventList>
</EPCISBody>
</epcis:EPCISDocument>

```

7.3 Sample XML: W2 → D

Reference File: <https://resources.gs1us.org/Portals/0/xml/LotChoreo-ExtendedSupplyChainExample2-W2toD.xml>

```

<?xml version="1.0" encoding="UTF-8" standalone="yes"?>
<!-- Lot Choreography End to End Examples: EXTENDED SUPPLY CHAIN - EXAMPLE 2: W2->D -->
<epcis:EPCISDocument xmlns:cbvmda="urn:epcglobal:cbv:mda"
xmlns:sbdh="http://www.unece.org/cefact/namespaces/StandardBusinessDocumentHeader"
xmlns:gslushc="http://epcis.gs1us.org/hc/ns" xmlns:epcis="urn:epcglobal:epcis:xsd:1"
schemaVersion="1.2" xsi:schemaLocation="urn:epcglobal:epcis:xsd:1 EPCglobal-epcis-1_2.xsd"
xmlns:xsi="http://www.w3.org/2001/XMLSchema-instance" creationDate="2014-05-30T15:14:27.574-
04:00">
  <EPCISHeader>
    <sbdh:StandardBusinessDocumentHeader>
      <sbdh:HeaderVersion>1.0</sbdh:HeaderVersion>
      <sbdh:Sender>
        <sbdh:Identifier
Authority="SGLN">urn:epc:id:sgln:9508888.00000.0</sbdh:Identifier>
      </sbdh:Sender>
      <sbdh:Receiver>
        <sbdh:Identifier
Authority="SGLN">urn:epc:id:sgln:5012345.00000.0</sbdh:Identifier>
      </sbdh:Receiver>
      <sbdh:DocumentIdentification>
        <sbdh:Standard>EPCglobal</sbdh:Standard>
        <sbdh:TypeVersion>1.0</sbdh:TypeVersion>
        <sbdh:InstanceIdentifier>1234567890</sbdh:InstanceIdentifier>
        <sbdh:Type>Events</sbdh:Type>

```

```

        <sbdh:CreationDateAndTime>2014-05-30T15:14:27.574-04:00</sbdh:CreationDateAndTime>
    </sbdh:DocumentIdentification>
</sbdh:StandardBusinessDocumentHeader>
<extension>
    <EPCISMasterData>
        <VocabularyList>
            <Vocabulary type="urn:epcglobal:epcis:vtype:EPCClass">
                <VocabularyElementList>
                    <VocabularyElement id="urn:epc:idpat:sgtin:030000.0000001.*">
                        <attribute
id="urn:epcglobal:cbv:mda#additionalTradeItemIdentification">0000000001</attribute>
                        <attribute
id="urn:epcglobal:cbv:mda#additionalTradeItemIdentificationTypeCode">FDA_NDC_11</attribute>
                        <attribute
id="urn:epcglobal:cbv:mda#manufacturerOfTradeItemPartyName">GS1 Pharma LLC</attribute>
                        <attribute
id="urn:epcglobal:cbv:mda#regulatedProductName">Epcistra</attribute>
                        <attribute id="urn:epcglobal:cbv:mda#dosageFormType">PILL</attribute>
                        <attribute
id="urn:epcglobal:cbv:mda#strengthDescription">100mg</attribute>
                        <attribute id="urn:epcglobal:cbv:mda#netContentDescription">500
pills</attribute>
                    </VocabularyElement>
                </VocabularyElementList>
            </Vocabulary>
            <Vocabulary type="urn:epcglobal:epcis:vtype:Location">
                <VocabularyElementList>
                    <VocabularyElement id="urn:epc:id:sgln:0614141.00000.0">
                        <attribute id="urn:epcglobal:cbv:mda#name">GS1 Drug Distro
LLC</attribute>
                        <attribute id="urn:epcglobal:cbv:mda#streetAddressOne">230 Park Ave
S</attribute>
                        <attribute id="urn:epcglobal:cbv:mda#city">New York</attribute>
                        <attribute id="urn:epcglobal:cbv:mda#state">NY</attribute>
                        <attribute id="urn:epcglobal:cbv:mda#postalCode">10003-
1502</attribute>
                        <attribute id="urn:epcglobal:cbv:mda#countryCode">US</attribute>
                    </VocabularyElement>
                    <VocabularyElement id="urn:epc:id:sgln:9508888.00000.0">
                        <attribute id="urn:epcglobal:cbv:mda#name">GS1 Cayman Islands
Wholesale</attribute>
                        <attribute id="urn:epcglobal:cbv:mda#streetAddressOne">1 Shamrock
Road</attribute>
                        <attribute id="urn:epcglobal:cbv:mda#city">Bodden Town</attribute>
                        <attribute id="urn:epcglobal:cbv:mda#countryCode">KY</attribute>
                    </VocabularyElement>
                    <VocabularyElement id="urn:epc:id:sgln:5012345.00000.0">
                        <attribute id="urn:epcglobal:cbv:mda#name">GS1 Pere et Fils
Pharmacy</attribute>
                        <attribute id="urn:epcglobal:cbv:mda#streetAddressOne">1313
Mockingbird Lane</attribute>
                        <attribute id="urn:epcglobal:cbv:mda#city">Paris</attribute>
                        <attribute id="urn:epcglobal:cbv:mda#state">TX</attribute>
                        <attribute id="urn:epcglobal:cbv:mda#postalCode">76543</attribute>
                        <attribute id="urn:epcglobal:cbv:mda#countryCode">US</attribute>
                    </VocabularyElement>
                </VocabularyElementList>
            </Vocabulary>
        </VocabularyList>
    </EPCISMasterData>
</extension>

```

```

    <gslushc:dscsaTransactionStatement>
      <gslushc:affirmTransactionStatement>true</gslushc:affirmTransactionStatement>
      <gslushc:legalNotice>Seller has complied with each applicable subsection of FDCA Sec.
581(27)(A)-(G). As indicated below, product was purchased directly from the manufacturer,
manufacturer's exclusive distributor or repackager who purchased directly from a
manufacturer.</gslushc:legalNotice>
    </gslushc:dscsaTransactionStatement>
  </EPCISHeader>
  <EPCISBody>
    <EventList>
      <!-- Transaction History (TH) -->
      <ObjectEvent>
        <eventTime>2014-04-01T11:00:00.000-04:00</eventTime>
        <eventTimeZoneOffset>-04:00</eventTimeZoneOffset>
        <epcList/>
        <action>OBSERVE</action>
        <bizStep>urn:epcglobal:cbv:bizstep:shipping</bizStep>
        <disposition>urn:epcglobal:cbv:disp:in_transit</disposition>
        <readPoint>
          <id>urn:epc:id:sgln:0614141.00000.0</id>
        </readPoint>
        <extension>
          <quantityList>
            <quantityElement>
              <!-- Since Lot is redacted from the TH sent by W1->W2,
              W2 captures the Lot# from the physical product in order to
include Lot information in TH sent to D -->
              <epcClass>urn:epc:class:lgtn:030000.0000001.L1</epcClass>
              <quantity>100</quantity>
            </quantityElement>
          </quantityList>
          <sourceList>
            <source
type="urn:epcglobal:cbv:sdt:owning_party">urn:epc:id:sgln:0614141.00000.0</source>
          </sourceList>
          <destinationList>
            <destination
type="urn:epcglobal:cbv:sdt:owning_party">urn:epc:id:sgln:9508888.00000.0</destination>
          </destinationList>
        </extension>
      </ObjectEvent>
      <!-- Transaction History (TH) -->
      <ObjectEvent>
        <eventTime>2014-04-03T11:00:00.000-04:00</eventTime>
        <eventTimeZoneOffset>-04:00</eventTimeZoneOffset>
        <epcList/>
        <action>OBSERVE</action>
        <bizStep>urn:epcglobal:cbv:bizstep:shipping</bizStep>
        <disposition>urn:epcglobal:cbv:disp:in_transit</disposition>
        <readPoint>
          <id>urn:epc:id:sgln:0614141.00000.0</id>
        </readPoint>
        <extension>
          <quantityList>
            <quantityElement>
              <!-- Since Lot is redacted from the TH sent by W1->W2,
              W2 captures the Lot# from the physical product in order to
include Lot information in TH sent to D -->
              <epcClass>urn:epc:class:lgtn:030000.0000001.L1</epcClass>
              <quantity>50</quantity>
            </quantityElement>
          </quantityList>
        </extension>
      </ObjectEvent>
    </EventList>
  </EPCISBody>
</EPCISHeader>

```

```

        </quantityList>
        <sourceList>
            <source
type="urn:epcglobal:cbv:sdt:owning_party">urn:epc:id:sgln:0614141.00000.0</source>
            </sourceList>
        <destinationList>
            <destination
type="urn:epcglobal:cbv:sdt:owning_party">urn:epc:id:sgln:9508888.00000.0</destination>
            </destinationList>
        </extension>
    </ObjectEvent>
    <!-- Transaction Information (TI) -->
    <ObjectEvent>
        <eventTime>2014-04-05T11:00:00.000-04:00</eventTime>
        <eventTimeZoneOffset>-04:00</eventTimeZoneOffset>
        <epcList/>
        <action>OBSERVE</action>
        <bizStep>urn:epcglobal:cbv:bizstep:shipping</bizStep>
        <disposition>urn:epcglobal:cbv:disp:in_transit</disposition>
        <readPoint>
            <id>urn:epc:id:sgln:9508888.00000.0</id>
        </readPoint>
        <extension>
            <quantityList>
                <quantityElement>
                    <!-- Since Lot is redacted from the TH sent by W1->W2,
                                     W2 captures the Lot# from the physical product in order to
include Lot information in TI sent to D -->
                    <epcClass>urn:epc:class:lgtn:030000.0000001.L1</epcClass>
                    <quantity>150</quantity>
                </quantityElement>
            </quantityList>
            <sourceList>
                <source
type="urn:epcglobal:cbv:sdt:owning_party">urn:epc:id:sgln:9508888.00000.0</source>
            </sourceList>
            <destinationList>
                <destination
type="urn:epcglobal:cbv:sdt:owning_party">urn:epc:id:sgln:5012345.00000.0</destination>
            </destinationList>
        </extension>

        <gslushc:receivedADirectPurchaseStatementFromPreviousWholesaleDistributor>true</gslushc:rece
ivedADirectPurchaseStatementFromPreviousWholesaleDistributor>
    </ObjectEvent>
</EventList>
</EPCISBody>
</epcis:EPCISDocument>

```

8 Extended Supply Chain Scenario – Example 3

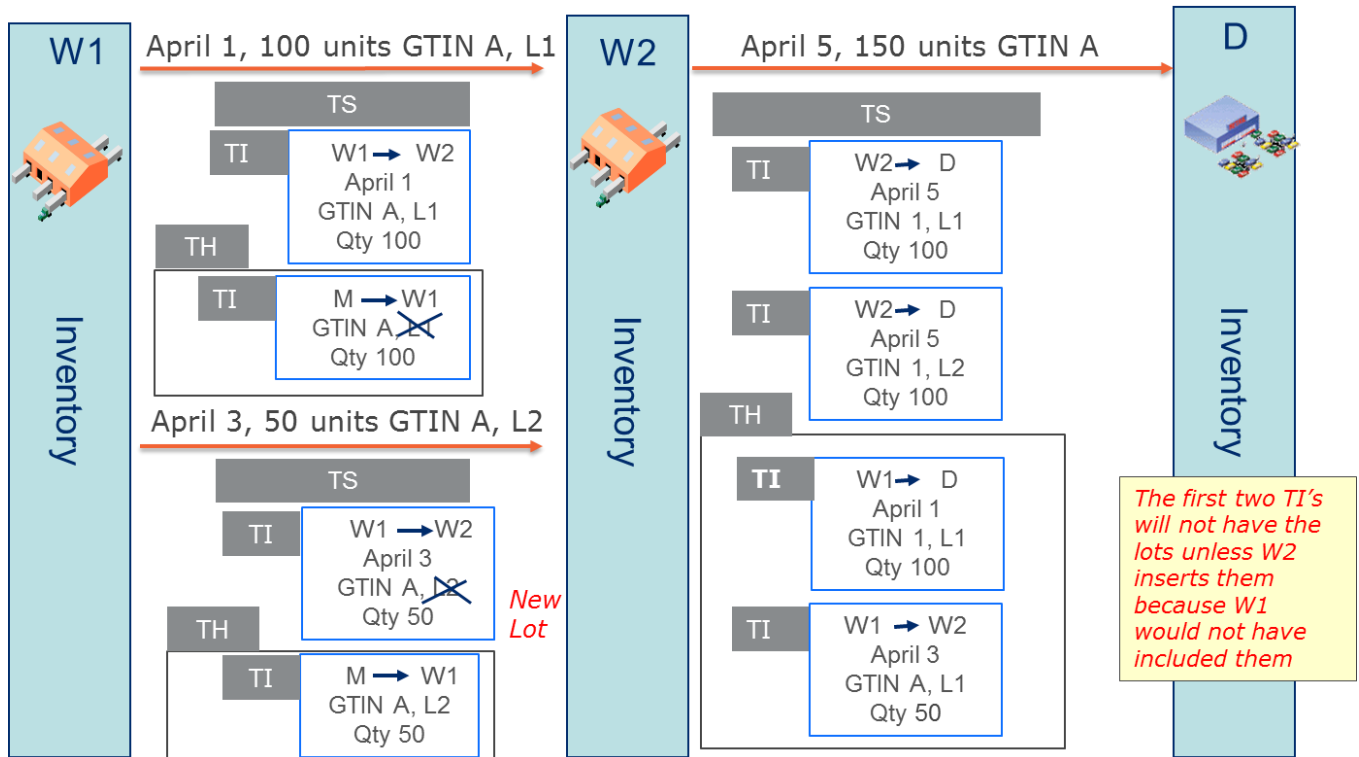

8.1 Sample XML: W1 → W2, April 1

 **Note:** The message content of the W1 → W2 transaction on April 1 in this example is identical to the content of the W1 → W2 transaction in [Extended Supply Chain Example 1](#).

Reference File: <https://resources.gs1us.org/Portals/0/xml/LotChoreo-ExtendedSupplyChainExample3-W1toW2Apr1.xml>

```
<?xml version="1.0" encoding="UTF-8" standalone="yes"?>
<!-- Lot Choreography End to End Examples: EXTENDED SUPPLY CHAIN - EXAMPLE 3: W1->W2, April 1 -
-->
<!-- The W1->W2 transaction on April 1 in this example is identical to the content in W1->W2
transaction in Extended Supply Chain Example 2 -->
<epcis:EPCISDocument xmlns:cbvmda="urn:epcglobal:cbv:mda"
xmlns:sbdh="http://www.unece.org/cefact/namespaces/StandardBusinessDocumentHeader"
xmlns:gslushc="http://epcis.gs1us.org/hc/ns" xmlns:epcis="urn:epcglobal:epcis:xsd:1"
schemaVersion="1.2" xsi:schemaLocation="urn:epcglobal:epcis:xsd:1 EPCglobal-epcis-1_2.xsd"
xmlns:xsi="http://www.w3.org/2001/XMLSchema-instance" creationDate="2014-05-30T15:14:27.574-
04:00">
  <EPCISHeader>
    <sbdh:StandardBusinessDocumentHeader>
      <sbdh:HeaderVersion>1.0</sbdh:HeaderVersion>
      <sbdh:Sender>
        <sbdh:Identifier
Authority="SGLN">urn:epc:id:sgln:0614141.00000.0</sbdh:Identifier>
        </sbdh:Sender>
      <sbdh:Receiver>
        <sbdh:Identifier
Authority="SGLN">urn:epc:id:sgln:9508888.00000.0</sbdh:Identifier>
        </sbdh:Receiver>
      <sbdh:DocumentIdentification>
        <sbdh:Standard>EPCglobal</sbdh:Standard>
        <sbdh:TypeVersion>1.0</sbdh:TypeVersion>
        <sbdh:InstanceIdentifier>1234567890</sbdh:InstanceIdentifier>
        <sbdh:Type>Events</sbdh:Type>
        <sbdh:CreationDateAndTime>2014-05-30T15:14:27.574-04:00</sbdh:CreationDateAndTime>
      </sbdh:DocumentIdentification>
    </sbdh:StandardBusinessDocumentHeader>
    <extension>
      <EPCISMasterData>
        <VocabularyList>
          <Vocabulary type="urn:epcglobal:epcis:vtype:EPCClass">
            <VocabularyElementList>
              <VocabularyElement id="urn:epc:idpat:sgtin:030000.0000001.*">
                <attribute
id="urn:epcglobal:cbv:mda#additionalTradeItemIdentification">00000000001</attribute>
                <attribute
id="urn:epcglobal:cbv:mda#additionalTradeItemIdentificationTypeCode">FDA_NDC_11</attribute>
                <attribute
id="urn:epcglobal:cbv:mda#manufacturerOfTradeItemPartyName">GS1 Pharma LLC</attribute>
                <attribute
id="urn:epcglobal:cbv:mda#regulatedProductName">Epcistra</attribute>
                <attribute id="urn:epcglobal:cbv:mda#dosageFormType">PILL</attribute>
                <attribute
id="urn:epcglobal:cbv:mda#strengthDescription">100mg</attribute>
                <attribute id="urn:epcglobal:cbv:mda#netContentDescription">500
pills</attribute>
              </VocabularyElement>
            </VocabularyElementList>
          </Vocabulary>
        </VocabularyList>
      </EPCISMasterData>
    </extension>
  </epcis:EPCISDocument>

```

```

</Vocabulary>
<Vocabulary type="urn:epcglobal:epcis:vtype:Location">
  <VocabularyElementList>
    <VocabularyElement id="urn:epc:id:sgln:030000.000000.0">
      <attribute id="urn:epcglobal:cbv:mda#name">GS1 Pharma LLC</attribute>
      <attribute id="urn:epcglobal:cbv:mda#streetAddressOne">1295 S George
Ave</attribute>
      <attribute id="urn:epcglobal:cbv:mda#streetAddressTwo">Room
378</attribute>
      <attribute id="urn:epcglobal:cbv:mda#city">Washington</attribute>
      <attribute id="urn:epcglobal:cbv:mda#state">DC</attribute>
      <attribute id="urn:epcglobal:cbv:mda#postalCode">12345-
6789</attribute>
      <attribute id="urn:epcglobal:cbv:mda#countryCode">US</attribute>
    </VocabularyElement>
    <VocabularyElement id="urn:epc:id:sgln:0614141.000000.0">
      <attribute id="urn:epcglobal:cbv:mda#name">GS1 Drug Distro
LLC</attribute>
      <attribute id="urn:epcglobal:cbv:mda#streetAddressOne">230 Park Ave
S</attribute>
      <attribute id="urn:epcglobal:cbv:mda#city">New York</attribute>
      <attribute id="urn:epcglobal:cbv:mda#state">NY</attribute>
      <attribute id="urn:epcglobal:cbv:mda#postalCode">10003-
1502</attribute>
      <attribute id="urn:epcglobal:cbv:mda#countryCode">US</attribute>
    </VocabularyElement>
    <VocabularyElement id="urn:epc:id:sgln:9508888.000000.0">
      <attribute id="urn:epcglobal:cbv:mda#name">GS1 Cayman Islands
Wholesale</attribute>
      <attribute id="urn:epcglobal:cbv:mda#streetAddressOne">1 Shamrock
Road</attribute>
      <attribute id="urn:epcglobal:cbv:mda#city">Bodden Town</attribute>
      <attribute id="urn:epcglobal:cbv:mda#countryCode">KY</attribute>
    </VocabularyElement>
  </VocabularyElementList>
</Vocabulary>
</VocabularyList>
</EPCISMasterData>
</extension>
<gslushc:dscsaTransactionStatement>
  <gslushc:affirmTransactionStatement>true</gslushc:affirmTransactionStatement>
  <gslushc:legalNotice>Seller has complied with each applicable subsection of FDCA Sec.
581(27)(A)-(G). As indicated below, product was purchased directly from the manufacturer,
manufacturer's exclusive distributor or repackager who purchased directly from a
manufacturer.</gslushc:legalNotice>
</gslushc:dscsaTransactionStatement>
</EPCISHeader>
<EPCISBody>
  <EventList>
    <!-- Transaction History (TH) -->
    <ObjectEvent>
      <eventTime>1970-01-01T00:00:00.000Z</eventTime>
      <eventTimeZoneOffset>+00:00</eventTimeZoneOffset>
      <epcList/>
      <action>OBSERVE</action>
      <bizStep>urn:epcglobal:cbv:bizstep:shipping</bizStep>
      <disposition>urn:epcglobal:cbv:disp:in_transit</disposition>
      <readPoint>
        <id>urn:epc:id:sgln:030000.000000.0</id>
      </readPoint>
      <extension>

```

```

    <quantityList>
      <quantityElement>
        <epcClass>urn:epc:idpat:sgtin:030000.0000001.*</epcClass>
        <quantity>100</quantity>
      </quantityElement>
    </quantityList>
    <sourceList>
      <source
type="urn:epcglobal:cbv:sdt:owning_party">urn:epc:id:sgln:030000.000000.0</source>
    </sourceList>
    <destinationList>
      <destination
type="urn:epcglobal:cbv:sdt:owning_party">urn:epc:id:sgln:0614141.00000.0</destination>
    </destinationList>
  </extension>
</ObjectEvent>
<!-- Transaction Information (TI) -->
<ObjectEvent>
  <eventTime>2014-04-01T11:00:00.000-04:00</eventTime>
  <eventTimeZoneOffset>-04:00</eventTimeZoneOffset>
  <epcList/>
  <action>OBSERVE</action>
  <bizStep>urn:epcglobal:cbv:bizstep:shipping</bizStep>
  <disposition>urn:epcglobal:cbv:disp:in_transit</disposition>
  <readPoint>
    <id>urn:epc:id:sgln:0614141.00000.0</id>
  </readPoint>
  <extension>
    <quantityList>
      <quantityElement>
        <epcClass>urn:epc:idpat:sgtin:030000.0000001.*</epcClass>
        <quantity>100</quantity>
      </quantityElement>
    </quantityList>
    <sourceList>
      <source
type="urn:epcglobal:cbv:sdt:owning_party">urn:epc:id:sgln:0614141.00000.0</source>
    </sourceList>
    <destinationList>
      <destination
type="urn:epcglobal:cbv:sdt:owning_party">urn:epc:id:sgln:9508888.00000.0</destination>
    </destinationList>
  </extension>
  <gslushc:directPurchase value="true"/>
</ObjectEvent>
</EventList>
</EPCISBody>
</epcis:EPCISDocument>

```

8.2 Sample XML: W1 → W2, April 3



Note: After redacting lot number and transaction date, the message content of the W1 → W2 transaction on April 3 in this example is identical to the content of the W1 → W2 transaction in [Extended Supply Chain Example 2](#).

Reference File: https://resources.gs1us.org/Portals/0/xml/LotChoreo-ExtendedSupplyChainExample3-W1toW2_Apr3.xml

```
<?xml version="1.0" encoding="UTF-8" standalone="yes"?>
<!-- Lot Choreography End to End Examples: EXTENDED SUPPLY CHAIN - EXAMPLE 3: W1->W2, April 3 -->
<!-- After redacting lot number and transaction date, the W1->W2 transaction on April 3 in this example is identical to the content in W1->W2 transaction in Extended Supply Chain Example 2 -->
<epcis:EPCISDocument xmlns:cbvmda="urn:epcglobal:cbv:mda"
xmlns:sbdh="http://www.unece.org/cefact/namespaces/StandardBusinessDocumentHeader"
xmlns:gslushc="http://epcis.gs1us.org/hc/ns" xmlns:epcis="urn:epcglobal:epcis:xsd:1"
schemaVersion="1.2" xsi:schemaLocation="urn:epcglobal:epcis:xsd:1 EPCglobal-epcis-1_2.xsd"
xmlns:xsi="http://www.w3.org/2001/XMLSchema-instance" creationDate="2014-05-30T15:14:27.574-04:00">
  <EPCISHeader>
    <sbdh:StandardBusinessDocumentHeader>
      <sbdh:HeaderVersion>1.0</sbdh:HeaderVersion>
      <sbdh:Sender>
        <sbdh:Identifier
Authority="SGLN">urn:epc:id:sgln:0614141.00000.0</sbdh:Identifier>
        </sbdh:Sender>
        <sbdh:Receiver>
        <sbdh:Identifier
Authority="SGLN">urn:epc:id:sgln:9508888.00000.0</sbdh:Identifier>
        </sbdh:Receiver>
        <sbdh:DocumentIdentification>
          <sbdh:Standard>EPCglobal</sbdh:Standard>
          <sbdh:TypeVersion>1.0</sbdh:TypeVersion>
          <sbdh:InstanceIdentifier>1234567890</sbdh:InstanceIdentifier>
          <sbdh:Type>Events</sbdh:Type>
          <sbdh:CreationDateAndTime>2014-05-30T15:14:27.574-04:00</sbdh:CreationDateAndTime>
        </sbdh:DocumentIdentification>
      </sbdh:StandardBusinessDocumentHeader>
      <extension>
        <EPCISMasterData>
          <VocabularyList>
            <Vocabulary type="urn:epcglobal:epcis:vtype:EPCClass">
              <VocabularyElementList>
                <VocabularyElement id="urn:epc:idpat:sgtin:030000.0000001.*">
                  <attribute
id="urn:epcglobal:cbv:mda#additionalTradeItemIdentification">00000000001</attribute>
                  <attribute
id="urn:epcglobal:cbv:mda#additionalTradeItemIdentificationTypeCode">FDA_NDC_11</attribute>
                  <attribute
id="urn:epcglobal:cbv:mda#manufacturerOfTradeItemPartyName">GS1 Pharma LLC</attribute>
                  <attribute
id="urn:epcglobal:cbv:mda#regulatedProductName">Epcistra</attribute>
                  <attribute id="urn:epcglobal:cbv:mda#dosageFormType">PILL</attribute>
                  <attribute
id="urn:epcglobal:cbv:mda#strengthDescription">100mg</attribute>
                  <attribute id="urn:epcglobal:cbv:mda#netContentDescription">500
pills</attribute>
                </VocabularyElementList>
              </VocabularyList>
            </extension>
          </EPCISMasterData>
        </extension>
      </EPCISHeader>
    </sbdh:StandardBusinessDocumentHeader>
  </epcis:EPCISDocument>
```

```

        </VocabularyElement>
      </VocabularyElementList>
    </Vocabulary>
    <Vocabulary type="urn:epcglobal:epcis:vtype:Location">
      <VocabularyElementList>
        <VocabularyElement id="urn:epc:id:sgln:030000.000000.0">
          <attribute id="urn:epcglobal:cbv:mda#name">GS1 Pharma LLC</attribute>
          <attribute id="urn:epcglobal:cbv:mda#streetAddressOne">1295 S George
Ave</attribute>
          <attribute id="urn:epcglobal:cbv:mda#streetAddressTwo">Room
378</attribute>
          <attribute id="urn:epcglobal:cbv:mda#city">Washington</attribute>
          <attribute id="urn:epcglobal:cbv:mda#state">DC</attribute>
          <attribute id="urn:epcglobal:cbv:mda#postalCode">12345-
6789</attribute>
          <attribute id="urn:epcglobal:cbv:mda#countryCode">US</attribute>
        </VocabularyElement>
        <VocabularyElement id="urn:epc:id:sgln:0614141.00000.0">
          <attribute id="urn:epcglobal:cbv:mda#name">GS1 Drug Distro
LLC</attribute>
          <attribute id="urn:epcglobal:cbv:mda#streetAddressOne">230 Park Ave
S</attribute>
          <attribute id="urn:epcglobal:cbv:mda#city">New York</attribute>
          <attribute id="urn:epcglobal:cbv:mda#state">NY</attribute>
          <attribute id="urn:epcglobal:cbv:mda#postalCode">10003-
1502</attribute>
          <attribute id="urn:epcglobal:cbv:mda#countryCode">US</attribute>
        </VocabularyElement>
        <VocabularyElement id="urn:epc:id:sgln:9508888.00000.0">
          <attribute id="urn:epcglobal:cbv:mda#name">GS1 Cayman Islands
Wholesale</attribute>
          <attribute id="urn:epcglobal:cbv:mda#streetAddressOne">1 Shamrock
Road</attribute>
          <attribute id="urn:epcglobal:cbv:mda#city">Bodden Town</attribute>
          <attribute id="urn:epcglobal:cbv:mda#countryCode">KY</attribute>
        </VocabularyElement>
      </VocabularyElementList>
    </Vocabulary>
  </VocabularyList>
</EPCISMasterData>
</extension>
<gslushc:dscsaTransactionStatement>
  <gslushc:affirmTransactionStatement>true</gslushc:affirmTransactionStatement>
  <gslushc:legalNotice>Seller has complied with each applicable subsection of FDCA Sec.
581(27)(A)-(G). As indicated below, product was purchased directly from the manufacturer,
manufacturer's exclusive distributor or repackager who purchased directly from a
manufacturer.</gslushc:legalNotice>
</gslushc:dscsaTransactionStatement>
</EPCISHeader>
<EPCISBody>
  <EventList>
    <!-- Transaction History (TH) -->
    <ObjectEvent>
      <eventTime>1970-01-01T00:00:00.000Z</eventTime>
      <eventTimeZoneOffset>+00:00</eventTimeZoneOffset>
      <epcList/>
      <action>OBSERVE</action>
      <bizStep>urn:epcglobal:cbv:bizstep:shipping</bizStep>
      <disposition>urn:epcglobal:cbv:disp:in_transit</disposition>
      <readPoint>
        <id>urn:epc:id:sgln:030000.000000.0</id>

```

```

</readPoint>
<extension>
  <quantityList>
    <quantityElement>
      <epcClass>urn:epc:idpat:sgtin:030000.0000001.*</epcClass>
      <quantity>50</quantity>
    </quantityElement>
  </quantityList>
  <sourceList>
    <source
type="urn:epcglobal:cbv:sdt:owning_party">urn:epc:id:sgln:030000.000000.0</source>
    </sourceList>
  <destinationList>
    <destination
type="urn:epcglobal:cbv:sdt:owning_party">urn:epc:id:sgln:0614141.00000.0</destination>
    </destinationList>
  </extension>
</ObjectEvent>
<!-- Transaction Information (TI) -->
<ObjectEvent>
  <eventTime>2014-04-03T11:00:00.000-04:00</eventTime>
  <eventTimeZoneOffset>-04:00</eventTimeZoneOffset>
  <epcList/>
  <action>OBSERVE</action>
  <bizStep>urn:epcglobal:cbv:bizstep:shipping</bizStep>
  <disposition>urn:epcglobal:cbv:disp:in_transit</disposition>
  <readPoint>
    <id>urn:epc:id:sgln:0614141.00000.0</id>
  </readPoint>
  <extension>
    <quantityList>
      <quantityElement>
        <epcClass>urn:epc:idpat:sgtin:030000.0000001.*</epcClass>
        <quantity>50</quantity>
      </quantityElement>
    </quantityList>
    <sourceList>
      <source
type="urn:epcglobal:cbv:sdt:owning_party">urn:epc:id:sgln:0614141.00000.0</source>
      </sourceList>
    <destinationList>
      <destination
type="urn:epcglobal:cbv:sdt:owning_party">urn:epc:id:sgln:9508888.00000.0</destination>
      </destinationList>
    </extension>
    <gslushc:directPurchase value="true"/>
  </ObjectEvent>
</EventList>
</EPCISBody>
</epcis:EPCISDocument>

```

8.3 Sample XML: W2 → D

Reference File: <https://resources.gs1us.org/Portals/0/xml/LotChoreo-ExtendedSupplyChainExample3-W2toD.xml>

```
<?xml version="1.0" encoding="UTF-8" standalone="yes"?>
<!-- Lot Choreography End to End Examples: EXTENDED SUPPLY CHAIN - EXAMPLE 3: W2->D, April 5 --
>
<epcis:EPCISDocument xmlns:cbvmda="urn:epcglobal:cbv:mda"
xmlns:sbdh="http://www.unece.org/cefact/namespaces/StandardBusinessDocumentHeader"
xmlns:gslushc="http://epcis.gs1us.org/hc/ns" xmlns:epcis="urn:epcglobal:epcis:xsd:1"
schemaVersion="1.2" xsi:schemaLocation="urn:epcglobal:epcis:xsd:1 EPCglobal-epcis-1_2.xsd"
xmlns:xsi="http://www.w3.org/2001/XMLSchema-instance" creationDate="2014-05-30T15:14:27.574-
04:00">
  <EPCISHeader>
    <sbdh:StandardBusinessDocumentHeader>
      <sbdh:HeaderVersion>1.0</sbdh:HeaderVersion>
      <sbdh:Sender>
        <sbdh:Identifier
Authority="SGLN">urn:epc:id:sgln:9508888.00000.0</sbdh:Identifier>
        </sbdh:Sender>
      <sbdh:Receiver>
        <sbdh:Identifier
Authority="SGLN">urn:epc:id:sgln:5012345.00000.0</sbdh:Identifier>
        </sbdh:Receiver>
      <sbdh:DocumentIdentification>
        <sbdh:Standard>EPCglobal</sbdh:Standard>
        <sbdh:TypeVersion>1.0</sbdh:TypeVersion>
        <sbdh:InstanceIdentifier>1234567890</sbdh:InstanceIdentifier>
        <sbdh:Type>Events</sbdh:Type>
        <sbdh:CreationDateAndTime>2014-05-30T15:14:27.574-04:00</sbdh:CreationDateAndTime>
      </sbdh:DocumentIdentification>
    </sbdh:StandardBusinessDocumentHeader>
    <extension>
      <EPCISMasterData>
        <VocabularyList>
          <Vocabulary type="urn:epcglobal:epcis:vtype:EPCClass">
            <VocabularyElementList>
              <VocabularyElement id="urn:epc:idpat:sgtin:030000.0000001.*">
                <attribute
id="urn:epcglobal:cbv:mda#additionalTradeItemIdentification">00000000001</attribute>
                <attribute
id="urn:epcglobal:cbv:mda#additionalTradeItemIdentificationTypeCode">FDA_NDC_11</attribute>
                <attribute
id="urn:epcglobal:cbv:mda#manufacturerOfTradeItemPartyName">GS1 Pharma LLC</attribute>
                <attribute
id="urn:epcglobal:cbv:mda#regulatedProductName">Epcistra</attribute>
                <attribute id="urn:epcglobal:cbv:mda#dosageFormType">PILL</attribute>
                <attribute
id="urn:epcglobal:cbv:mda#strengthDescription">100mg</attribute>
                <attribute id="urn:epcglobal:cbv:mda#netContentDescription">500
pills</attribute>
              </VocabularyElement>
            </VocabularyElementList>
          </Vocabulary>
          <Vocabulary type="urn:epcglobal:epcis:vtype:Location">
            <VocabularyElementList>
              <VocabularyElement id="urn:epc:id:sgln:0614141.00000.0">
                <attribute id="urn:epcglobal:cbv:mda#name">GS1 Drug Distro
LLC</attribute>
```

```

        <attribute id="urn:epcglobal:cbv:mda#streetAddressOne">230 Park Ave
S</attribute>
        <attribute id="urn:epcglobal:cbv:mda#city">New York</attribute>
        <attribute id="urn:epcglobal:cbv:mda#state">NY</attribute>
        <attribute id="urn:epcglobal:cbv:mda#postalCode">10003-
1502</attribute>
        <attribute id="urn:epcglobal:cbv:mda#countryCode">US</attribute>
</VocabularyElement>
<VocabularyElement id="urn:epc:id:sgln:9508888.00000.0">
  <attribute id="urn:epcglobal:cbv:mda#name">GS1 Cayman Islands
Wholesale</attribute>
  <attribute id="urn:epcglobal:cbv:mda#streetAddressOne">1 Shamrock
Road</attribute>
  <attribute id="urn:epcglobal:cbv:mda#city">Bodden Town</attribute>
  <attribute id="urn:epcglobal:cbv:mda#countryCode">KY</attribute>
</VocabularyElement>
<VocabularyElement id="urn:epc:id:sgln:5012345.00000.0">
  <attribute id="urn:epcglobal:cbv:mda#name">GS1 Pere et Fils
Pharmacy</attribute>
  <attribute id="urn:epcglobal:cbv:mda#streetAddressOne">1313
Mockingbird Lane</attribute>
  <attribute id="urn:epcglobal:cbv:mda#city">Paris</attribute>
  <attribute id="urn:epcglobal:cbv:mda#state">TX</attribute>
  <attribute id="urn:epcglobal:cbv:mda#postalCode">76543</attribute>
  <attribute id="urn:epcglobal:cbv:mda#countryCode">US</attribute>
</VocabularyElement>
</VocabularyElementList>
</Vocabulary>
</VocabularyList>
</EPCISMasterData>
</extension>
<gslushc:dscsaTransactionStatement>
  <gslushc:affirmTransactionStatement>true</gslushc:affirmTransactionStatement>
  <gslushc:legalNotice>Seller has complied with each applicable subsection of FDCA Sec.
581(27)(A)-(G). As indicated below, product was purchased directly from the manufacturer,
manufacturer's exclusive distributor or repackager who purchased directly from a
manufacturer.</gslushc:legalNotice>
</gslushc:dscsaTransactionStatement>
</EPCISHeader>
<EPCISBody>
  <EventList>
    <!-- Transaction History (TH) -->
    <ObjectEvent>
      <eventTime>2014-04-01T11:00:00.000-04:00</eventTime>
      <eventTimeZoneOffset>-04:00</eventTimeZoneOffset>
      <epcList/>
      <action>OBSERVE</action>
      <bizStep>urn:epcglobal:cbv:bizstep:shipping</bizStep>
      <disposition>urn:epcglobal:cbv:disp:in_transit</disposition>
      <readPoint>
        <id>urn:epc:id:sgln:0614141.00000.0</id>
      </readPoint>
      <extension>
        <quantityList>
          <quantityElement>
            <!-- Since Lot is redacted from the TH sent by W1->W2,
            W2 captures the Lot# from the physical product in order to
            include Lot information in TH sent to D -->
            <epcClass>urn:epc:class:lgtn:030000.0000001.L1</epcClass>
            <quantity>100</quantity>
          </quantityElement>

```



```

        </quantityList>
        <sourceList>
            <source
type="urn:epcglobal:cbv:sdt:owning_party">urn:epc:id:sgln:0614141.00000.0</source>
            </sourceList>
        <destinationList>
            <destination
type="urn:epcglobal:cbv:sdt:owning_party">urn:epc:id:sgln:9508888.00000.0</destination>
            </destinationList>
        </extension>
    </ObjectEvent>
    <!-- Transaction History (TH) -->
    <ObjectEvent>
        <eventTime>2014-04-03T11:00:00.000-04:00</eventTime>
        <eventTimeZoneOffset>-04:00</eventTimeZoneOffset>
        <epcList/>
        <action>OBSERVE</action>
        <bizStep>urn:epcglobal:cbv:bizstep:shipping</bizStep>
        <disposition>urn:epcglobal:cbv:disp:in_transit</disposition>
        <readPoint>
            <id>urn:epc:id:sgln:0614141.00000.0</id>
        </readPoint>
        <extension>
            <quantityList>
                <quantityElement>
                    <!-- Since Lot is redacted from the TH sent by W1->W2,
                                     W2 captures the Lot# from the physical product in order to
include Lot information in TH sent to D -->
                    <epcClass>urn:epc:class:lgtn:030000.0000001.L2</epcClass>
                    <quantity>50</quantity>
                </quantityElement>
            </quantityList>
            <sourceList>
                <source
type="urn:epcglobal:cbv:sdt:owning_party">urn:epc:id:sgln:0614141.00000.0</source>
            </sourceList>
            <destinationList>
                <destination
type="urn:epcglobal:cbv:sdt:owning_party">urn:epc:id:sgln:9508888.00000.0</destination>
            </destinationList>
        </extension>
    </ObjectEvent>
    <!-- Transaction Information (TI) -->
    <ObjectEvent>
        <eventTime>2014-04-05T11:00:00.000-04:00</eventTime>
        <eventTimeZoneOffset>-04:00</eventTimeZoneOffset>
        <epcList/>
        <action>OBSERVE</action>
        <bizStep>urn:epcglobal:cbv:bizstep:shipping</bizStep>
        <disposition>urn:epcglobal:cbv:disp:in_transit</disposition>
        <readPoint>
            <id>urn:epc:id:sgln:9508888.00000.0</id>
        </readPoint>
        <extension>
            <quantityList>
                <quantityElement>
                    <!-- Since Lot is redacted from the TH sent by W1->W2,
                                     W2 captures the Lot# from the physical product in order to
include Lot information in TI sent to D -->
                    <epcClass>urn:epc:class:lgtn:030000.0000001.L1</epcClass>
                    <quantity>100</quantity>
                </quantityElement>
            </quantityList>
        </extension>
    </ObjectEvent>

```

```
        </quantityElement>
        <quantityElement>
          <!-- Since Lot is redacted from the TH sent by W1->W2,
               W2 captures the Lot# from the physical product in order to
include Lot information in TI sent to D -->
          <epcClass>urn:epc:class:lgtn:030000.0000001.L2</epcClass>
          <quantity>50</quantity>
        </quantityElement>
      </quantityList>
      <sourceList>
        <source
type="urn:epcglobal:cbv:sdt:owning_party">urn:epc:id:sgln:9508888.00000.0</source>
      </sourceList>
      <destinationList>
        <destination
type="urn:epcglobal:cbv:sdt:owning_party">urn:epc:id:sgln:5012345.00000.0</destination>
      </destinationList>
    </extension>

    <gslushc:receivedADirectPurchaseStatementFromPreviousWholesaleDistributor>true</gslushc:rece
ivedADirectPurchaseStatementFromPreviousWholesaleDistributor>
  </ObjectEvent>
</EventList>
</EPCISBody>
</epcis:EPCISDocument>
```

9 Extended Supply Chain Scenario – Example 4

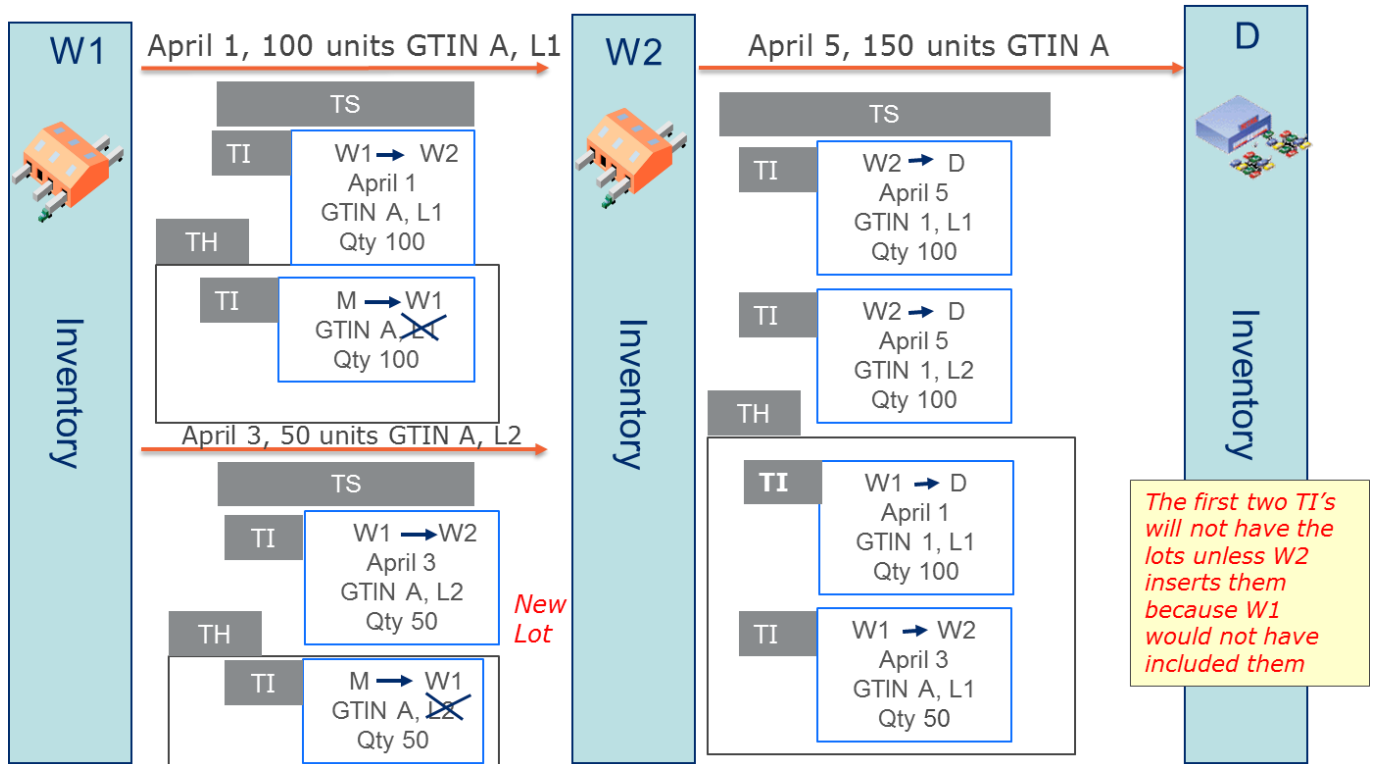

9.1 Sample XML: W1 → W2, April 1

 **Note:** The message content of the W1 → W2 transaction on April 1 in this example is identical to the content of the W1 → W2 transaction in [Extended Supply Chain Example 1](#).

Reference File: <https://resources.gs1us.org/Portals/0/xml/LotChoreo-ExtendedSupplyChainExample4-W1toW2Apr1.xml>

```
<?xml version="1.0" encoding="UTF-8" standalone="yes"?>
<!-- Lot Choreography End to End Examples: EXTENDED SUPPLY CHAIN - EXAMPLE 4: W1->W2, April 1 -
-->
<!-- The W1->W2 transaction on April 1 in this example is identical to the content in W1->W2
transaction in Extended Supply Chain Example 1 -->
<epcis:EPCISDocument xmlns:cbvmda="urn:epcglobal:cbv:mda"
xmlns:sbdh="http://www.unece.org/cefact/namespaces/StandardBusinessDocumentHeader"
xmlns:gslushc="http://epcis.gs1us.org/hc/ns" xmlns:epcis="urn:epcglobal:epcis:xsd:1"
schemaVersion="1.2" xsi:schemaLocation="urn:epcglobal:epcis:xsd:1 EPCglobal-epcis-1_2.xsd"
xmlns:xsi="http://www.w3.org/2001/XMLSchema-instance" creationDate="2014-05-30T15:14:27.574-
04:00">
  <EPCISHeader>
    <sbdh:StandardBusinessDocumentHeader>
      <sbdh:HeaderVersion>1.0</sbdh:HeaderVersion>
      <sbdh:Sender>
        <sbdh:Identifier
Authority="SGLN">urn:epc:id:sgln:0614141.00000.0</sbdh:Identifier>
        </sbdh:Sender>
      <sbdh:Receiver>
        <sbdh:Identifier
Authority="SGLN">urn:epc:id:sgln:9508888.00000.0</sbdh:Identifier>
        </sbdh:Receiver>
      <sbdh:DocumentIdentification>
        <sbdh:Standard>EPCglobal</sbdh:Standard>
        <sbdh:TypeVersion>1.0</sbdh:TypeVersion>
        <sbdh:InstanceIdentifier>1234567890</sbdh:InstanceIdentifier>
        <sbdh:Type>Events</sbdh:Type>
        <sbdh:CreationDateAndTime>2014-05-30T15:14:27.574-04:00</sbdh:CreationDateAndTime>
      </sbdh:DocumentIdentification>
    </sbdh:StandardBusinessDocumentHeader>
    <extension>
      <EPCISMasterData>
        <VocabularyList>
          <Vocabulary type="urn:epcglobal:epcis:vtype:EPCClass">
            <VocabularyElementList>
              <VocabularyElement id="urn:epc:idpat:sgtin:030000.0000001.*">
                <attribute
id="urn:epcglobal:cbv:mda#additionalTradeItemIdentification">00000000001</attribute>
                <attribute
id="urn:epcglobal:cbv:mda#additionalTradeItemIdentificationTypeCode">FDA_NDC_11</attribute>
                <attribute
id="urn:epcglobal:cbv:mda#manufacturerOfTradeItemPartyName">GS1 Pharma LLC</attribute>
                <attribute
id="urn:epcglobal:cbv:mda#regulatedProductName">Epcistra</attribute>
                <attribute id="urn:epcglobal:cbv:mda#dosageFormType">PILL</attribute>
                <attribute
id="urn:epcglobal:cbv:mda#strengthDescription">100mg</attribute>
                <attribute id="urn:epcglobal:cbv:mda#netContentDescription">500
pills</attribute>
              </VocabularyElement>
            </VocabularyElementList>
          </Vocabulary>
        </VocabularyList>
      </EPCISMasterData>
    </extension>
  </EPCISHeader>
</epcis:EPCISDocument>
```

```

</Vocabulary>
<Vocabulary type="urn:epcglobal:epcis:vtype:Location">
  <VocabularyElementList>
    <VocabularyElement id="urn:epc:id:sgln:030000.000000.0">
      <attribute id="urn:epcglobal:cbv:mda#name">GS1 Pharma LLC</attribute>
      <attribute id="urn:epcglobal:cbv:mda#streetAddressOne">1295 S George
Ave</attribute>
      <attribute id="urn:epcglobal:cbv:mda#streetAddressTwo">Room
378</attribute>
      <attribute id="urn:epcglobal:cbv:mda#city">Washington</attribute>
      <attribute id="urn:epcglobal:cbv:mda#state">DC</attribute>
      <attribute id="urn:epcglobal:cbv:mda#postalCode">12345-
6789</attribute>
      <attribute id="urn:epcglobal:cbv:mda#countryCode">US</attribute>
    </VocabularyElement>
    <VocabularyElement id="urn:epc:id:sgln:0614141.000000.0">
      <attribute id="urn:epcglobal:cbv:mda#name">GS1 Drug Distro
LLC</attribute>
      <attribute id="urn:epcglobal:cbv:mda#streetAddressOne">230 Park Ave
S</attribute>
      <attribute id="urn:epcglobal:cbv:mda#city">New York</attribute>
      <attribute id="urn:epcglobal:cbv:mda#state">NY</attribute>
      <attribute id="urn:epcglobal:cbv:mda#postalCode">10003-
1502</attribute>
      <attribute id="urn:epcglobal:cbv:mda#countryCode">US</attribute>
    </VocabularyElement>
    <VocabularyElement id="urn:epc:id:sgln:9508888.000000.0">
      <attribute id="urn:epcglobal:cbv:mda#name">GS1 Cayman Islands
Wholesale</attribute>
      <attribute id="urn:epcglobal:cbv:mda#streetAddressOne">1 Shamrock
Road</attribute>
      <attribute id="urn:epcglobal:cbv:mda#city">Bodden Town</attribute>
      <attribute id="urn:epcglobal:cbv:mda#countryCode">KY</attribute>
    </VocabularyElement>
  </VocabularyElementList>
</Vocabulary>
</VocabularyList>
</EPCISMasterData>
</extension>
<gslushc:dscsaTransactionStatement>
  <gslushc:affirmTransactionStatement>true</gslushc:affirmTransactionStatement>
  <gslushc:legalNotice>Seller has complied with each applicable subsection of FDCA Sec.
581(27)(A)-(G). As indicated below, product was purchased directly from the manufacturer,
manufacturer's exclusive distributor or repackager who purchased directly from a
manufacturer.</gslushc:legalNotice>
</gslushc:dscsaTransactionStatement>
</EPCISHeader>
<EPCISBody>
  <EventList>
    <!-- Transaction History (TH) -->
    <ObjectEvent>
      <eventTime>1970-01-01T00:00:00.000Z</eventTime>
      <eventTimeZoneOffset>+00:00</eventTimeZoneOffset>
      <epcList/>
      <action>OBSERVE</action>
      <bizStep>urn:epcglobal:cbv:bizstep:shipping</bizStep>
      <disposition>urn:epcglobal:cbv:disp:in_transit</disposition>
      <readPoint>
        <id>urn:epc:id:sgln:030000.000000.0</id>
      </readPoint>
      <extension>

```

```

    <quantityList>
      <quantityElement>
        <epcClass>urn:epc:idpat:sgtin:030000.0000001.*</epcClass>
        <quantity>100</quantity>
      </quantityElement>
    </quantityList>
    <sourceList>
      <source
type="urn:epcglobal:cbv:sdt:owning_party">urn:epc:id:sgln:030000.000000.0</source>
    </sourceList>
    <destinationList>
      <destination
type="urn:epcglobal:cbv:sdt:owning_party">urn:epc:id:sgln:0614141.00000.0</destination>
    </destinationList>
  </extension>
</ObjectEvent>
<!-- Transaction Information (TI) -->
<ObjectEvent>
  <eventTime>2014-04-01T11:00:00.000-04:00</eventTime>
  <eventTimeZoneOffset>-04:00</eventTimeZoneOffset>
  <epcList/>
  <action>OBSERVE</action>
  <bizStep>urn:epcglobal:cbv:bizstep:shipping</bizStep>
  <disposition>urn:epcglobal:cbv:disp:in_transit</disposition>
  <readPoint>
    <id>urn:epc:id:sgln:0614141.00000.0</id>
  </readPoint>
  <extension>
    <quantityList>
      <quantityElement>
        <epcClass>urn:epc:idpat:sgtin:030000.0000001.*</epcClass>
        <quantity>100</quantity>
      </quantityElement>
    </quantityList>
    <sourceList>
      <source
type="urn:epcglobal:cbv:sdt:owning_party">urn:epc:id:sgln:0614141.00000.0</source>
    </sourceList>
    <destinationList>
      <destination
type="urn:epcglobal:cbv:sdt:owning_party">urn:epc:id:sgln:9508888.00000.0</destination>
    </destinationList>
  </extension>
  <gslushc:directPurchase value="true"/>
</ObjectEvent>
</EventList>
</EPCISBody>
</epcis:EPCISDocument>

```

9.2 Sample XML: W1 → W2, April 3



Note: After redacting lot number and transaction date, the message content of the W1 → W2 transaction on April 3 in this example is identical to the content of the W1 → W2 transaction in [Extended Supply Chain Example 2](#) and [Extended Supply Chain Example 3](#).

Reference File: https://resources.gs1us.org/Portals/0/xml/LotChoreo-ExtendedSupplyChainExample4-W1toW2_Apr3.xml

```
<?xml version="1.0" encoding="UTF-8" standalone="yes"?>
<!-- Lot Choreography End to End Examples: EXTENDED SUPPLY CHAIN - EXAMPLE 4: W1->W2, April 3 -->
<!-- After redacting lot number and transaction date, the W1->W2 transaction on April 3 in this example is identical to the content in W1->W2 transaction in Extended Supply Chain Example 2 -->
<epcis:EPCISDocument xmlns:cbvmda="urn:epcglobal:cbv:mda"
xmlns:sbdh="http://www.unece.org/cefact/namespaces/StandardBusinessDocumentHeader"
xmlns:gslushc="http://epcis.gs1us.org/hc/ns" xmlns:epcis="urn:epcglobal:epcis:xsd:1"
schemaVersion="1.2" xsi:schemaLocation="urn:epcglobal:epcis:xsd:1 EPCglobal-epcis-1_2.xsd"
xmlns:xsi="http://www.w3.org/2001/XMLSchema-instance" creationDate="2014-05-30T15:14:27.574-04:00">
  <EPCISHeader>
    <sbdh:StandardBusinessDocumentHeader>
      <sbdh:HeaderVersion>1.0</sbdh:HeaderVersion>
      <sbdh:Sender>
        <sbdh:Identifier
Authority="SGLN">urn:epc:id:sgln:0614141.00000.0</sbdh:Identifier>
        </sbdh:Sender>
      <sbdh:Receiver>
        <sbdh:Identifier
Authority="SGLN">urn:epc:id:sgln:9508888.00000.0</sbdh:Identifier>
        </sbdh:Receiver>
      <sbdh:DocumentIdentification>
        <sbdh:Standard>EPCglobal</sbdh:Standard>
        <sbdh:TypeVersion>1.0</sbdh:TypeVersion>
        <sbdh:InstanceIdentifier>1234567890</sbdh:InstanceIdentifier>
        <sbdh:Type>Events</sbdh:Type>
        <sbdh:CreationDateAndTime>2014-05-30T15:14:27.574-04:00</sbdh:CreationDateAndTime>
      </sbdh:DocumentIdentification>
    </sbdh:StandardBusinessDocumentHeader>
    <extension>
      <EPCISMasterData>
        <VocabularyList>
          <Vocabulary type="urn:epcglobal:epcis:vtype:EPCClass">
            <VocabularyElementList>
              <VocabularyElement id="urn:epc:idpat:sgtin:030000.0000001.*">
                <attribute
id="urn:epcglobal:cbv:mda#additionalTradeItemIdentification">00000000001</attribute>
                <attribute
id="urn:epcglobal:cbv:mda#additionalTradeItemIdentificationTypeCode">FDA_NDC_11</attribute>
                <attribute
id="urn:epcglobal:cbv:mda#manufacturerOfTradeItemPartyName">GS1 Pharma LLC</attribute>
                <attribute
id="urn:epcglobal:cbv:mda#regulatedProductName">Epcistra</attribute>
                <attribute id="urn:epcglobal:cbv:mda#dosageFormType">PILL</attribute>
                <attribute
id="urn:epcglobal:cbv:mda#strengthDescription">100mg</attribute>
                <attribute id="urn:epcglobal:cbv:mda#netContentDescription">500
pills</attribute>
              </VocabularyElement>
            </VocabularyElementList>
          </Vocabulary>
        </VocabularyList>
      </EPCISMasterData>
    </extension>
  </epcis:EPCISDocument>

```

```

        </VocabularyElement>
      </VocabularyElementList>
    </Vocabulary>
    <Vocabulary type="urn:epcglobal:epcis:vtype:Location">
      <VocabularyElementList>
        <VocabularyElement id="urn:epc:id:sgln:030000.000000.0">
          <attribute id="urn:epcglobal:cbv:mda#name">GS1 Pharma LLC</attribute>
          <attribute id="urn:epcglobal:cbv:mda#streetAddressOne">1295 S George
Ave</attribute>
          <attribute id="urn:epcglobal:cbv:mda#streetAddressTwo">Room
378</attribute>
          <attribute id="urn:epcglobal:cbv:mda#city">Washington</attribute>
          <attribute id="urn:epcglobal:cbv:mda#state">DC</attribute>
          <attribute id="urn:epcglobal:cbv:mda#postalCode">12345-
6789</attribute>
          <attribute id="urn:epcglobal:cbv:mda#countryCode">US</attribute>
        </VocabularyElement>
        <VocabularyElement id="urn:epc:id:sgln:0614141.00000.0">
          <attribute id="urn:epcglobal:cbv:mda#name">GS1 Drug Distro
LLC</attribute>
          <attribute id="urn:epcglobal:cbv:mda#streetAddressOne">230 Park Ave
S</attribute>
          <attribute id="urn:epcglobal:cbv:mda#city">New York</attribute>
          <attribute id="urn:epcglobal:cbv:mda#state">NY</attribute>
          <attribute id="urn:epcglobal:cbv:mda#postalCode">10003-
1502</attribute>
          <attribute id="urn:epcglobal:cbv:mda#countryCode">US</attribute>
        </VocabularyElement>
        <VocabularyElement id="urn:epc:id:sgln:9508888.00000.0">
          <attribute id="urn:epcglobal:cbv:mda#name">GS1 Cayman Islands
Wholesale</attribute>
          <attribute id="urn:epcglobal:cbv:mda#streetAddressOne">1 Shamrock
Road</attribute>
          <attribute id="urn:epcglobal:cbv:mda#city">Bodden Town</attribute>
          <attribute id="urn:epcglobal:cbv:mda#countryCode">KY</attribute>
        </VocabularyElement>
      </VocabularyElementList>
    </Vocabulary>
  </VocabularyList>
</EPCISMasterData>
</extension>
<gslushc:dscsaTransactionStatement>
  <gslushc:affirmTransactionStatement>true</gslushc:affirmTransactionStatement>
  <gslushc:legalNotice>Seller has complied with each applicable subsection of FDCA Sec.
581(27)(A)-(G). As indicated below, product was purchased directly from the manufacturer,
manufacturer's exclusive distributor or repackager who purchased directly from a
manufacturer.</gslushc:legalNotice>
</gslushc:dscsaTransactionStatement>
</EPCISHeader>
<EPCISBody>
  <EventList>
    <!-- Transaction History (TH) -->
    <ObjectEvent>
      <eventTime>1970-01-01T00:00:00.000Z</eventTime>
      <eventTimeZoneOffset>+00:00</eventTimeZoneOffset>
      <epcList/>
      <action>OBSERVE</action>
      <bizStep>urn:epcglobal:cbv:bizstep:shipping</bizStep>
      <disposition>urn:epcglobal:cbv:disp:in_transit</disposition>
      <readPoint>
        <id>urn:epc:id:sgln:030000.000000.0</id>

```



```

</readPoint>
<extension>
  <quantityList>
    <quantityElement>
      <epcClass>urn:epc:idpat:sgtin:030000.0000001.*</epcClass>
      <quantity>50</quantity>
    </quantityElement>
  </quantityList>
  <sourceList>
    <source
type="urn:epcglobal:cbv:sdt:owning_party">urn:epc:id:sgln:030000.000000.0</source>
    </sourceList>
  <destinationList>
    <destination
type="urn:epcglobal:cbv:sdt:owning_party">urn:epc:id:sgln:0614141.00000.0</destination>
    </destinationList>
  </extension>
</ObjectEvent>
<!-- Transaction Information (TI) -->
<ObjectEvent>
  <eventTime>2014-04-03T11:00:00.000-04:00</eventTime>
  <eventTimeZoneOffset>-04:00</eventTimeZoneOffset>
  <epcList/>
  <action>OBSERVE</action>
  <bizStep>urn:epcglobal:cbv:bizstep:shipping</bizStep>
  <disposition>urn:epcglobal:cbv:disp:in_transit</disposition>
  <readPoint>
    <id>urn:epc:id:sgln:0614141.00000.0</id>
  </readPoint>
  <extension>
    <quantityList>
      <quantityElement>
        <epcClass>urn:epc:idpat:sgtin:030000.0000001.*</epcClass>
        <quantity>50</quantity>
      </quantityElement>
    </quantityList>
    <sourceList>
      <source
type="urn:epcglobal:cbv:sdt:owning_party">urn:epc:id:sgln:0614141.00000.0</source>
      </sourceList>
    <destinationList>
      <destination
type="urn:epcglobal:cbv:sdt:owning_party">urn:epc:id:sgln:9508888.00000.0</destination>
      </destinationList>
    </extension>
    <gslushc:directPurchase value="true"/>
  </ObjectEvent>
</EventList>
</EPCISBody>
</epcis:EPCISDocument>

```

9.3 Sample XML: W2 → D



Note: The W2 → D transaction in this example is almost identical to the W2 → D transaction in Example 3: only the quantity is different.

Reference File: <https://resources.gs1us.org/Portals/0/xml/LotChoreo-ExtendedSupplyChainExample4-W2toD.xml>

```
<?xml version="1.0" encoding="UTF-8" standalone="yes"?>
<!-- Lot Choreography End to End Examples: EXTENDED SUPPLY CHAIN - EXAMPLE 4: W2->D, April 5 --
>
<epcis:EPCISDocument xmlns:cbvmda="urn:epcglobal:cbv:mda"
xmlns:sbdh="http://www.unece.org/cefact/namespaces/StandardBusinessDocumentHeader"
xmlns:gs1ushc="http://epcis.gs1us.org/hc/ns" xmlns:epcis="urn:epcglobal:epcis:xsd:1"
schemaVersion="1.2" xsi:schemaLocation="urn:epcglobal:epcis:xsd:1 EPCglobal-epcis-1_2.xsd"
xmlns:xsi="http://www.w3.org/2001/XMLSchema-instance" creationDate="2014-05-30T15:14:27.574-
04:00">
  <EPCISHeader>
    <sbdh:StandardBusinessDocumentHeader>
      <sbdh:HeaderVersion>1.0</sbdh:HeaderVersion>
      <sbdh:Sender>
        <sbdh:Identifier
Authority="SGLN">urn:epc:id:sgln:9508888.00000.0</sbdh:Identifier>
        </sbdh:Identifier>
        <sbdh:Sender>
        </sbdh:Sender>
      <sbdh:Receiver>
        <sbdh:Identifier
Authority="SGLN">urn:epc:id:sgln:5012345.00000.0</sbdh:Identifier>
        </sbdh:Identifier>
        <sbdh:Receiver>
        </sbdh:Receiver>
      <sbdh:DocumentIdentification>
        <sbdh:Standard>EPCglobal</sbdh:Standard>
        <sbdh:TypeVersion>1.0</sbdh:TypeVersion>
        <sbdh:InstanceIdentifier>1234567890</sbdh:InstanceIdentifier>
        <sbdh:Type>Events</sbdh:Type>
        <sbdh:CreationDateAndTime>2014-05-30T15:14:27.574-04:00</sbdh:CreationDateAndTime>
      </sbdh:DocumentIdentification>
    </sbdh:StandardBusinessDocumentHeader>
    <extension>
      <EPCISMasterData>
        <VocabularyList>
          <Vocabulary type="urn:epcglobal:epcis:vtype:EPCClass">
            <VocabularyElementList>
              <VocabularyElement id="urn:epc:idpat:sgtin:030000.0000001.*">
                <attribute
id="urn:epcglobal:cbv:mda#additionalTradeItemIdentification">00000000001</attribute>
                <attribute
id="urn:epcglobal:cbv:mda#additionalTradeItemIdentificationTypeCode">FDA_NDC_11</attribute>
                <attribute
id="urn:epcglobal:cbv:mda#manufacturerOfTradeItemPartyName">GS1 Pharma LLC</attribute>
                <attribute
id="urn:epcglobal:cbv:mda#regulatedProductName">Epcistra</attribute>
                <attribute id="urn:epcglobal:cbv:mda#dosageFormType">PILL</attribute>
                <attribute
id="urn:epcglobal:cbv:mda#strengthDescription">100mg</attribute>
                <attribute id="urn:epcglobal:cbv:mda#netContentDescription">500
pills</attribute>
              </VocabularyElement>
            </VocabularyElementList>
          </Vocabulary>
          <Vocabulary type="urn:epcglobal:epcis:vtype:Location">
```

```

    <VocabularyElementList>
      <VocabularyElement id="urn:epc:id:sgln:0614141.00000.0">
        <attribute id="urn:epcglobal:cbv:mda#name">GS1 Drug Distro
LLC</attribute>
        <attribute id="urn:epcglobal:cbv:mda#streetAddressOne">230 Park Ave
S</attribute>
        <attribute id="urn:epcglobal:cbv:mda#city">New York</attribute>
        <attribute id="urn:epcglobal:cbv:mda#state">NY</attribute>
        <attribute id="urn:epcglobal:cbv:mda#postalCode">10003-
1502</attribute>
        <attribute id="urn:epcglobal:cbv:mda#countryCode">US</attribute>
      </VocabularyElement>
      <VocabularyElement id="urn:epc:id:sgln:9508888.00000.0">
        <attribute id="urn:epcglobal:cbv:mda#name">GS1 Cayman Islands
Wholesale</attribute>
        <attribute id="urn:epcglobal:cbv:mda#streetAddressOne">1 Shamrock
Road</attribute>
        <attribute id="urn:epcglobal:cbv:mda#city">Bodden Town</attribute>
        <attribute id="urn:epcglobal:cbv:mda#countryCode">KY</attribute>
      </VocabularyElement>
      <VocabularyElement id="urn:epc:id:sgln:5012345.00000.0">
        <attribute id="urn:epcglobal:cbv:mda#name">GS1 Pere et Fils
Pharmacy</attribute>
        <attribute id="urn:epcglobal:cbv:mda#streetAddressOne">1313
Mockingbird Lane</attribute>
        <attribute id="urn:epcglobal:cbv:mda#city">Paris</attribute>
        <attribute id="urn:epcglobal:cbv:mda#state">TX</attribute>
        <attribute id="urn:epcglobal:cbv:mda#postalCode">76543</attribute>
        <attribute id="urn:epcglobal:cbv:mda#countryCode">US</attribute>
      </VocabularyElement>
    </VocabularyElementList>
  </Vocabulary>
</VocabularyList>
</EPCISMasterData>
</extension>
<gslushc:dscsaTransactionStatement>
  <gslushc:affirmTransactionStatement>true</gslushc:affirmTransactionStatement>
  <gslushc:legalNotice>Seller has complied with each applicable subsection of FDCA Sec.
581(27)(A)-(G). As indicated below, product was purchased directly from the manufacturer,
manufacturer's exclusive distributor or repackager who purchased directly from a
manufacturer.</gslushc:legalNotice>
</gslushc:dscsaTransactionStatement>
</EPCISHeader>
<EPCISBody>
  <EventList>
    <!-- Transaction History (TH) -->
    <ObjectEvent>
      <eventTime>2014-04-01T11:00:00.000-04:00</eventTime>
      <eventTimeZoneOffset>-04:00</eventTimeZoneOffset>
      <epcList/>
      <action>OBSERVE</action>
      <bizStep>urn:epcglobal:cbv:bizstep:shipping</bizStep>
      <disposition>urn:epcglobal:cbv:disp:in_transit</disposition>
      <readPoint>
        <id>urn:epc:id:sgln:0614141.00000.0</id>
      </readPoint>
      <extension>
        <quantityList>
          <quantityElement>
            <!-- Since Lot is redacted from the TH sent by W1->W2,

```

W2 captures the Lot# from the physical product in order to include Lot information in TH sent to D -->

```

    <epcClass>urn:epc:class:lgtin:030000.0000001.L1</epcClass>
    <quantity>20</quantity>
  </quantityElement>
</quantityList>
<sourceList>
  <source
type="urn:epcglobal:cbv:sdt:owning_party">urn:epc:id:sgln:0614141.00000.0</source>
</sourceList>
<destinationList>
  <destination
type="urn:epcglobal:cbv:sdt:owning_party">urn:epc:id:sgln:9508888.00000.0</destination>
</destinationList>
</extension>
</ObjectEvent>

```

<!-- Transaction History (TH) -->

```

<ObjectEvent>
  <eventTime>2014-04-03T11:00:00.000-04:00</eventTime>
  <eventTimeZoneOffset>-04:00</eventTimeZoneOffset>
  <epcList/>
  <action>OBSERVE</action>
  <bizStep>urn:epcglobal:cbv:bizstep:shipping</bizStep>
  <disposition>urn:epcglobal:cbv:disp:in_transit</disposition>
  <readPoint>
    <id>urn:epc:id:sgln:0614141.00000.0</id>
  </readPoint>
  <extension>

```

W2 captures the Lot# from the physical product in order to include Lot information in TH sent to D -->

```

    <epcClass>urn:epc:class:lgtin:030000.0000001.L2</epcClass>
    <quantity>10</quantity>
  </quantityElement>
</quantityList>
<sourceList>
  <source
type="urn:epcglobal:cbv:sdt:owning_party">urn:epc:id:sgln:0614141.00000.0</source>
</sourceList>
<destinationList>
  <destination
type="urn:epcglobal:cbv:sdt:owning_party">urn:epc:id:sgln:9508888.00000.0</destination>
</destinationList>
</extension>
</ObjectEvent>

```

<!-- Transaction Information (TI) -->

```

<ObjectEvent>
  <eventTime>2014-04-05T11:00:00.000-04:00</eventTime>
  <eventTimeZoneOffset>-04:00</eventTimeZoneOffset>
  <epcList/>
  <action>OBSERVE</action>
  <bizStep>urn:epcglobal:cbv:bizstep:shipping</bizStep>
  <disposition>urn:epcglobal:cbv:disp:in_transit</disposition>
  <readPoint>
    <id>urn:epc:id:sgln:9508888.00000.0</id>
  </readPoint>
  <extension>
    <quantityList>
      <quantityElement>

```

```

        <!-- Since Lot is redacted from the TH sent by W1->W2,
             W2 captures the Lot# from the physical product in order to
include Lot information in TI sent to D -->
        <epcClass>urn:epc:class:lgtin:030000.0000001.L1</epcClass>
        <quantity>20</quantity>
    </quantityElement>
</quantityElement>
        <!-- Since Lot is redacted from the TH sent by W1->W2,
             W2 captures the Lot# from the physical product in order to
include Lot information in TI sent to D -->
        <epcClass>urn:epc:class:lgtin:030000.0000001.L2</epcClass>
        <quantity>10</quantity>
    </quantityElement>
</quantityList>
<sourceList>
    <source
type="urn:epcglobal:cbv:sdt:owning_party">urn:epc:id:sgln:9508888.00000.0</source>
    </sourceList>
<destinationList>
    <destination
type="urn:epcglobal:cbv:sdt:owning_party">urn:epc:id:sgln:5012345.00000.0</destination>
    </destinationList>
</extension>

    <gslushc:receivedADirectPurchaseStatementFromPreviousWholesaleDistributor>true</gslushc:rece
ivedADirectPurchaseStatementFromPreviousWholesaleDistributor>
    </ObjectEvent>
</EventList>
</EPCISBody>
</epcis:EPCISDocument>

```

10 Contract Manufacturing Scenario – Example 1

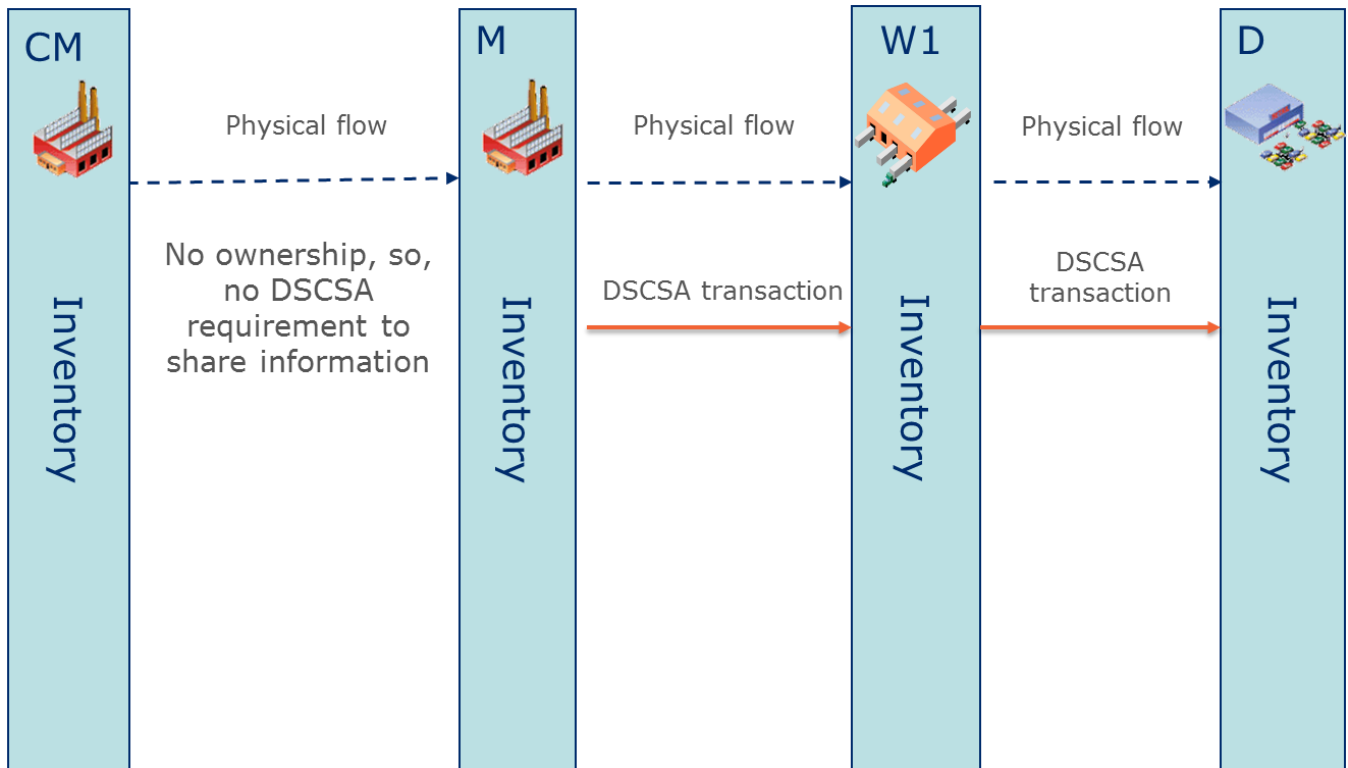

10.1 Sample XML: M → W1

 **Note:** Because the contract manufacturer has no ownership of the product, the DSCSA transaction begins with the manufacturer. Therefore, the message content of the M → W1 transaction in this example is identical to the content of the M → W1 transaction in the [Direct Purchase Example 1](#).

Reference File: <https://resources.gs1us.org/Portals/0/xml/LotChoreo-Contract Manufacturing Example-MtoW1.xml>

```
<?xml version="1.0" encoding="UTF-8" standalone="yes"?>
<!-- Lot Choreography End to End Examples: CONTRACT MANUFACTURING - EXAMPLE 1: M->W1 -->
<!-- The M->W1 transaction in this example is identical to the M->W1 content for Direct
Purchase Example1 -->
<epcis:EPCISDocument xmlns:cbvmda="urn:epcglobal:cbv:mda"
xmlns:sbdh="http://www.unece.org/cefact/namespaces/StandardBusinessDocumentHeader"
xmlns:gslushc="http://epcis.gs1us.org/hc/ns" xmlns:epcis="urn:epcglobal:epcis:xsd:1"
schemaVersion="1.2" xsi:schemaLocation="urn:epcglobal:epcis:xsd:1 EPCglobal-epcis-1_2.xsd"
xmlns:xsi="http://www.w3.org/2001/XMLSchema-instance" creationDate="2014-05-30T15:14:27.574-
04:00">
  <EPCISHeader>
    <sbdh:StandardBusinessDocumentHeader>
      <sbdh:HeaderVersion>1.0</sbdh:HeaderVersion>
      <sbdh:Sender>
        <sbdh:Identifier
Authority="SGLN">urn:epc:id:sgln:030000.000000.0</sbdh:Identifier>
      </sbdh:Sender>
      <sbdh:Receiver>
        <sbdh:Identifier
Authority="SGLN">urn:epc:id:sgln:0614141.000000.0</sbdh:Identifier>
      </sbdh:Receiver>
      <sbdh:DocumentIdentification>
        <sbdh:Standard>EPCglobal</sbdh:Standard>
        <sbdh:TypeVersion>1.0</sbdh:TypeVersion>
        <sbdh:InstanceIdentifier>1234567890</sbdh:InstanceIdentifier>
        <sbdh:Type>Events</sbdh:Type>
        <sbdh:CreationDateAndTime>2014-05-30T15:14:27.574-04:00</sbdh:CreationDateAndTime>
      </sbdh:DocumentIdentification>
    </sbdh:StandardBusinessDocumentHeader>
    <extension>
      <EPCISMasterData>
        <VocabularyList>
          <Vocabulary type="urn:epcglobal:epcis:vtype:EPCClass">
            <VocabularyElementList>
              <VocabularyElement id="urn:epc:class:lgtn:030000.0000001.L1">
                <attribute id="urn:epcglobal:cbv:mda#itemExpirationDate">2015-10-
31</attribute>
              </VocabularyElement>
              <VocabularyElement id="urn:epc:idpat:sgtin:030000.0000001.*">
                <attribute
id="urn:epcglobal:cbv:mda#additionalTradeItemIdentification">00000000001</attribute>
                <attribute
id="urn:epcglobal:cbv:mda#additionalTradeItemIdentificationTypeCode">FDA_NDC_11</attribute>
                <attribute
id="urn:epcglobal:cbv:mda#regulatedProductName">Epcistra</attribute>
                <attribute
id="urn:epcglobal:cbv:mda#manufacturerOfTradeItemPartyName">GS1 Pharma LLC</attribute>
                <attribute id="urn:epcglobal:cbv:mda#dosageFormType">PILL</attribute>
              </VocabularyElement>
            </VocabularyElementList>
          </Vocabulary>
        </VocabularyList>
      </EPCISMasterData>
    </extension>
  </EPCISHeader>
</epcis:EPCISDocument>
```

```

        <attribute
id="urn:epcglobal:cbv:mda#strengthDescription">100mg</attribute>
        <attribute id="urn:epcglobal:cbv:mda#netContentDescription">500
pills</attribute>
    </VocabularyElement>
</VocabularyElementList>
</Vocabulary>
<Vocabulary type="urn:epcglobal:epcis:vtype:Location">
    <VocabularyElementList>
        <VocabularyElement id="urn:epc:id:sgln:030000.000000.0">
            <attribute id="urn:epcglobal:cbv:mda#name">GS1 Pharma LLC</attribute>
            <attribute id="urn:epcglobal:cbv:mda#streetAddressOne">1295 S George
Ave</attribute>
            <attribute id="urn:epcglobal:cbv:mda#streetAddressTwo">Room
378</attribute>
            <attribute id="urn:epcglobal:cbv:mda#city">Washington</attribute>
            <attribute id="urn:epcglobal:cbv:mda#state">DC</attribute>
            <attribute id="urn:epcglobal:cbv:mda#postalCode">12345-
6789</attribute>
            <attribute id="urn:epcglobal:cbv:mda#countryCode">US</attribute>
        </VocabularyElement>
    <VocabularyElement id="urn:epc:id:sgln:0614141.00000.0">
        <attribute id="urn:epcglobal:cbv:mda#name">GS1 Drug Distro
LLC</attribute>
        <attribute id="urn:epcglobal:cbv:mda#streetAddressOne">230 Park Ave
S</attribute>
        <attribute id="urn:epcglobal:cbv:mda#city">New York</attribute>
        <attribute id="urn:epcglobal:cbv:mda#state">NY</attribute>
        <attribute id="urn:epcglobal:cbv:mda#postalCode">10003-
1502</attribute>
            <attribute id="urn:epcglobal:cbv:mda#countryCode">US</attribute>
        </VocabularyElement>
    </VocabularyElementList>
</Vocabulary>
</VocabularyList>
</EPCISMasterData>
</extension>
<gslushc:dcsaTransactionStatement>
    <gslushc:affirmTransactionStatement>true</gslushc:affirmTransactionStatement>
    <gslushc:legalNotice>Seller has complied with each applicable subsection of FDCA Sec.
581 (27) (A) - (G).</gslushc:legalNotice>
</gslushc:dcsaTransactionStatement>
</EPCISHeader>
<EPCISBody>
    <EventList>
        <!-- Transaction Information (TI) -->
        <ObjectEvent>
            <eventTime>2014-04-01T10:11:12Z</eventTime>
            <eventTimeZoneOffset>-05:00</eventTimeZoneOffset>
            <epcList/>
            <action>OBSERVE</action>
            <bizStep>urn:epcglobal:cbv:bizstep:shipping</bizStep>
            <disposition>urn:epcglobal:cbv:disp:in_transit</disposition>
            <readPoint>
                <id>urn:epc:id:sgln:030000.000000.0</id>
            </readPoint>
            <extension>
                <quantityList>
                    <quantityElement>
                        <epcClass>urn:epc:class:lgtn:030000.0000001.L1</epcClass>
                        <quantity>100</quantity>
                    </quantityElement>
                </quantityList>
            </extension>
        </ObjectEvent>
    </EventList>
</EPCISBody>
</EPCISMessage>
</EPCIS>

```



```

        </quantityElement>
    </quantityList>
    <sourceList>
        <source
type="urn:epcglobal:cbv:sdt:owning_party">urn:epc:id:sgln:030000.000000.0</source>
        </sourceList>
    <destinationList>
        <destination
type="urn:epcglobal:cbv:sdt:owning_party">urn:epc:id:sgln:0614141.000000.0</destination>
        </destinationList>
    </extension>
</ObjectEvent>
</EventList>
</EPCISBody>
</epcis:EPCISDocument>

```

10.2 Sample XML: W1 → D



Note: The message content of the DSCSA transaction for W1 → D in this example is identical to the content of the W1 → D in the [Direct Purchase Example 1](#).

Reference File: <https://resources.gs1us.org/Portals/0/xml/LotChoreo-Contract Manufacturing Example-W1toD.xml>

```

<?xml version="1.0" encoding="UTF-8" standalone="yes"?>
<!-- Lot Choreography End to End Examples: CONTRACT MANUFACTURING - EXAMPLE 1: W1->D -->
<!-- The W1->D transaction in this example is identical to the W1->D content for Direct
Purchase Example1 -->
<epcis:EPCISDocument xmlns:cbvmda="urn:epcglobal:cbv:mda"
xmlns:sbdh="http://www.unece.org/cefact/namespaces/StandardBusinessDocumentHeader"
xmlns:gslushc="http://epcis.gslus.org/hc/ns" xmlns:epcis="urn:epcglobal:epcis:xsd:1"
schemaVersion="1.2" xsi:schemaLocation="urn:epcglobal:epcis:xsd:1 EPCglobal-epcis-1_2.xsd"
xmlns:xsi="http://www.w3.org/2001/XMLSchema-instance" creationDate="2014-05-30T15:14:27.574-
04:00">
    <EPCISHeader>
        <sbdh:StandardBusinessDocumentHeader>
            <sbdh:HeaderVersion>1.0</sbdh:HeaderVersion>
            <sbdh:Sender>
                <sbdh:Identifier
Authority="SGLN">urn:epc:id:sgln:0614141.000000.0</sbdh:Identifier>
            </sbdh:Sender>
            <sbdh:Receiver>
                <sbdh:Identifier
Authority="SGLN">urn:epc:id:sgln:5012345.000000.0</sbdh:Identifier>
            </sbdh:Receiver>
            <sbdh:DocumentIdentification>
                <sbdh:Standard>EPCglobal</sbdh:Standard>
                <sbdh:TypeVersion>1.0</sbdh:TypeVersion>
                <sbdh:InstanceIdentifier>1234567890</sbdh:InstanceIdentifier>
                <sbdh:Type>Events</sbdh:Type>
                <sbdh:CreationDateAndTime>2014-05-30T15:14:27.574-04:00</sbdh:CreationDateAndTime>
            </sbdh:DocumentIdentification>
        </sbdh:StandardBusinessDocumentHeader>
        <extension>
            <EPCISMasterData>
                <VocabularyList>
                    <Vocabulary type="urn:epcglobal:epcis:vtype:EPCClass">
                        <VocabularyElementList>
                            <VocabularyElement id="urn:epc:idpat:sgtin:030000.0000001.*">

```

```

        <attribute
id="urn:epcglobal:cbv:mda#additionalTradeItemIdentification">0000000001</attribute>
        <attribute
id="urn:epcglobal:cbv:mda#additionalTradeItemIdentificationTypeCode">FDA_NDC_11</attribute>
        <attribute
id="urn:epcglobal:cbv:mda#regulatedProductName">Epcistra</attribute>
        <attribute
id="urn:epcglobal:cbv:mda#manufacturerOfTradeItemPartyName">GS1 Pharma LLC</attribute>
        <attribute id="urn:epcglobal:cbv:mda#dosageFormType">PILL</attribute>
        <attribute
id="urn:epcglobal:cbv:mda#strengthDescription">100mg</attribute>
        <attribute id="urn:epcglobal:cbv:mda#netContentDescription">500
pills</attribute>
    </VocabularyElement>
</VocabularyElementList>
</Vocabulary>
<Vocabulary type="urn:epcglobal:epcis:vtype:Location">
    <VocabularyElementList>
        <VocabularyElement id="urn:epc:id:sgln:030000.000000.0">
            <attribute id="urn:epcglobal:cbv:mda#name">GS1 Pharma LLC</attribute>
            <attribute id="urn:epcglobal:cbv:mda#streetAddressOne">1295 S George
Ave</attribute>
            <attribute id="urn:epcglobal:cbv:mda#streetAddressTwo">Room
378</attribute>
            <attribute id="urn:epcglobal:cbv:mda#city">Washington</attribute>
            <attribute id="urn:epcglobal:cbv:mda#state">DC</attribute>
            <attribute id="urn:epcglobal:cbv:mda#postalCode">12345-
6789</attribute>
            <attribute id="urn:epcglobal:cbv:mda#countryCode">US</attribute>
        </VocabularyElement>
        <VocabularyElement id="urn:epc:id:sgln:0614141.000000.0">
            <attribute id="urn:epcglobal:cbv:mda#name">GS1 Drug Distro
LLC</attribute>
            <attribute id="urn:epcglobal:cbv:mda#streetAddressOne">230 Park Ave
S</attribute>
            <attribute id="urn:epcglobal:cbv:mda#city">New York</attribute>
            <attribute id="urn:epcglobal:cbv:mda#state">NY</attribute>
            <attribute id="urn:epcglobal:cbv:mda#postalCode">10003-
1502</attribute>
            <attribute id="urn:epcglobal:cbv:mda#countryCode">US</attribute>
        </VocabularyElement>
    </VocabularyElementList>
</Vocabulary>
<VocabularyElement id="urn:epc:id:sgln:5012345.000000.0">
    <attribute id="urn:epcglobal:cbv:mda#name">GS1 Pere et Fils
Pharmacy</attribute>
    <attribute id="urn:epcglobal:cbv:mda#streetAddressOne">1313
Mockingbird Lane</attribute>
    <attribute id="urn:epcglobal:cbv:mda#city">Paris</attribute>
    <attribute id="urn:epcglobal:cbv:mda#state">TX</attribute>
    <attribute id="urn:epcglobal:cbv:mda#postalCode">76543</attribute>
    <attribute id="urn:epcglobal:cbv:mda#countryCode">US</attribute>
</VocabularyElement>
</VocabularyElementList>
</Vocabulary>
</VocabularyList>
</EPCISMasterData>
</extension>
<gslushc:dscsaTransactionStatement>
    <gslushc:affirmTransactionStatement>true</gslushc:affirmTransactionStatement>
    <gslushc:legalNotice>Seller has complied with each applicable subsection of FDCA Sec.
581(27)(A)-(G). As indicated below, product was purchased directly from the manufacturer,

```

```

manufacturer's exclusive distributor or repackager who purchased directly from a
manufacturer.</gslushc:legalNotice>
  </gslushc:dscsaTransactionStatement>
</EPCISHeader>
<EPCISBody>
  <EventList>
    <!-- Transaction History (TH) -->
    <ObjectEvent>
      <eventTime>1970-01-01T00:00:00.000Z</eventTime>
      <eventTimeZoneOffset>+00:00</eventTimeZoneOffset>
      <epcList/>
      <action>OBSERVE</action>
      <bizStep>urn:epcglobal:cbv:bizstep:shipping</bizStep>
      <disposition>urn:epcglobal:cbv:disp:in_transit</disposition>
      <readPoint>
        <id>urn:epc:id:sgln:030000.000000.0</id>
      </readPoint>
      <extension>
        <quantityList>
          <quantityElement>
            <epcClass>urn:epc:idpat:sgtin:030000.0000001.*</epcClass>
            <quantity>50</quantity>
          </quantityElement>
        </quantityList>
        <sourceList>
          <source
type="urn:epcglobal:cbv:sdt:owning_party">urn:epc:id:sgln:030000.000000.0</source>
          </sourceList>
          <destinationList>
            <destination
type="urn:epcglobal:cbv:sdt:owning_party">urn:epc:id:sgln:0614141.00000.0</destination>
            </destinationList>
          </extension>
        </ObjectEvent>
    <!-- Transaction Information (TI) -->
    <ObjectEvent>
      <eventTime>2014-04-05T11:00:00.000-04:00</eventTime>
      <eventTimeZoneOffset>-04:00</eventTimeZoneOffset>
      <epcList/>
      <action>OBSERVE</action>
      <bizStep>urn:epcglobal:cbv:bizstep:shipping</bizStep>
      <disposition>urn:epcglobal:cbv:disp:in_transit</disposition>
      <readPoint>
        <id>urn:epc:id:sgln:0614141.00000.0</id>
      </readPoint>
      <extension>
        <quantityList>
          <quantityElement>
            <epcClass>urn:epc:idpat:sgtin:030000.0000001.*</epcClass>
            <quantity>50</quantity>
          </quantityElement>
        </quantityList>
        <sourceList>
          <source
type="urn:epcglobal:cbv:sdt:owning_party">urn:epc:id:sgln:0614141.00000.0</source>
          </sourceList>
          <destinationList>
            <destination
type="urn:epcglobal:cbv:sdt:owning_party">urn:epc:id:sgln:5012345.00000.0</destination>
            </destinationList>
          </extension>

```

```
        <gslushc:directPurchase value="true"/>
    </ObjectEvent>
</EventList>
</EPCISBody>
</epcis:EPCISDocument>
```

11 Co-License Partner (CLP) Scenario – Example 1

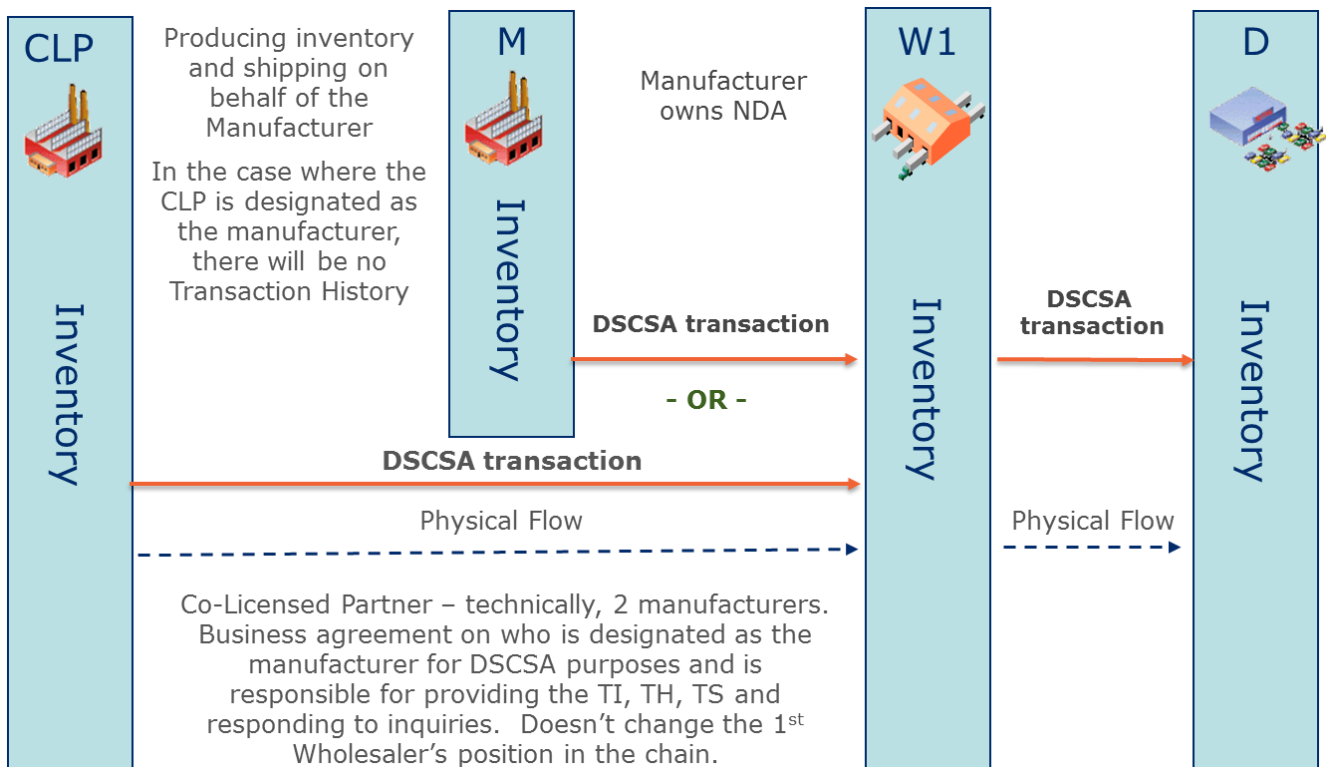

11.1 Sample XML: CLP as the Designated DSCSA Transaction Owner, CLP → W1

 **Note:** This example illustrates a scenario where the co-licensed partner serves as the designated manufacturer for DSCSA purposes, and therefore is the party responsible for providing the TI, TH and TS.

Reference File: <https://resources.gs1us.org/Portals/0/xml/LotChoreo-CoLicensedPartner Example-CLPtoW1.xml>

```
<?xml version="1.0" encoding="UTF-8" standalone="yes"?>
<!-- Lot Choreography End to End Examples: CO-LICENSE PARTNER - EXAMPLE 1:
      CO-LICENSED PARTNER (CLP) AS THE DESIGNATED DSCSA TRANSACTION OWNER, CLP->W1 -->
<epcis:EPCISDocument xmlns:cbvmda="urn:epcglobal:cbv:mda"
  xmlns:sbdh="http://www.unece.org/cefact/namespaces/StandardBusinessDocumentHeader"
  xmlns:gslushc="http://epcis.gs1us.org/hc/ns" xmlns:epcis="urn:epcglobal:epcis:xsd:1"
  schemaVersion="1.2" xsi:schemaLocation="urn:epcglobal:epcis:xsd:1 EPCglobal-epcis-1_2.xsd"
  xmlns:xsi="http://www.w3.org/2001/XMLSchema-instance" creationDate="2014-05-30T15:14:27.574-
  04:00">
  <EPCISHeader>
    <sbdh:StandardBusinessDocumentHeader>
      <sbdh:HeaderVersion>1.0</sbdh:HeaderVersion>
      <sbdh:Sender>
        <sbdh:Identifier
  Authority="SGLN">urn:epc:id:sgln:032468.000000.0</sbdh:Identifier>
        </sbdh:Identifier>
      </sbdh:Sender>
      <sbdh:Receiver>
        <sbdh:Identifier
  Authority="SGLN">urn:epc:id:sgln:0614141.000000.0</sbdh:Identifier>
        </sbdh:Identifier>
      </sbdh:Receiver>
      <sbdh:DocumentIdentification>
        <sbdh:Standard>EPCglobal</sbdh:Standard>
        <sbdh:TypeVersion>1.0</sbdh:TypeVersion>
        <sbdh:InstanceIdentifier>1234567890</sbdh:InstanceIdentifier>
        <sbdh:Type>Events</sbdh:Type>
        <sbdh:CreationDateAndTime>2014-05-30T15:14:27.574-04:00</sbdh:CreationDateAndTime>
      </sbdh:DocumentIdentification>
    </sbdh:StandardBusinessDocumentHeader>
    <extension>
      <EPCISMasterData>
        <VocabularyList>
          <Vocabulary type="urn:epcglobal:epcis:vtype:EPCClass">
            <VocabularyElementList>
              <VocabularyElement id="urn:epc:class:lgtin:030000.0000001.L1">
                <attribute id="urn:epcglobal:cbv:mda#itemExpirationDate">2015-10-
  31</attribute>
              </VocabularyElement>
              <VocabularyElement id="urn:epc:idpat:sgtin:030000.0000001.*">
                <attribute
  id="urn:epcglobal:cbv:mda#additionalTradeItemIdentification">0000000001</attribute>
                <attribute
  id="urn:epcglobal:cbv:mda#additionalTradeItemIdentificationTypeCode">FDA_NDC_11</attribute>
                <attribute
  id="urn:epcglobal:cbv:mda#regulatedProductName">Epcistra</attribute>
                <attribute
  id="urn:epcglobal:cbv:mda#manufacturerOfTradeItemPartyName">GS1 Pharma LLC</attribute>
                <attribute id="urn:epcglobal:cbv:mda#dosageFormType">PILL</attribute>
                <attribute
  id="urn:epcglobal:cbv:mda#strengthDescription">100mg</attribute>
```

```

                    <attribute id="urn:epcglobal:cbv:mda#netContentDescription">500
pills</attribute>
                </VocabularyElement>
            </VocabularyElementList>
        </Vocabulary>
        <Vocabulary type="urn:epcglobal:epcis:vtype:Location">
            <VocabularyElementList>
                <VocabularyElement id="urn:epc:id:sgln:030000.000000.0">
                    <attribute id="urn:epcglobal:cbv:mda#name">GS1 Pharma LLC</attribute>
                    <attribute id="urn:epcglobal:cbv:mda#streetAddressOne">1295 S George
Ave</attribute>
                    <attribute id="urn:epcglobal:cbv:mda#streetAddressTwo">Room
378</attribute>
                    <attribute id="urn:epcglobal:cbv:mda#city">Washington</attribute>
                    <attribute id="urn:epcglobal:cbv:mda#state">DC</attribute>
                    <attribute id="urn:epcglobal:cbv:mda#postalCode">12345-
6789</attribute>
                    <attribute id="urn:epcglobal:cbv:mda#countryCode">US</attribute>
                </VocabularyElement>
            <VocabularyElement id="urn:epc:id:sgln:032468.000000.0">
                <attribute id="urn:epcglobal:cbv:mda#name">GS1 Biotech
LLC</attribute>
                <attribute id="urn:epcglobal:cbv:mda#streetAddressOne">1295 S
Technology Ct</attribute>
                <attribute id="urn:epcglobal:cbv:mda#streetAddressTwo">Room
412</attribute>
                <attribute id="urn:epcglobal:cbv:mda#city">Cambridge</attribute>
                <attribute id="urn:epcglobal:cbv:mda#state">MA</attribute>
                <attribute id="urn:epcglobal:cbv:mda#postalCode">02138</attribute>
                <attribute id="urn:epcglobal:cbv:mda#countryCode">US</attribute>
            </VocabularyElement>
            <VocabularyElement id="urn:epc:id:sgln:0614141.00000.0">
                <attribute id="urn:epcglobal:cbv:mda#name">GS1 Drug Distro
LLC</attribute>
                <attribute id="urn:epcglobal:cbv:mda#streetAddressOne">230 Park Ave
S</attribute>
                <attribute id="urn:epcglobal:cbv:mda#city">New York</attribute>
                <attribute id="urn:epcglobal:cbv:mda#state">NY</attribute>
                <attribute id="urn:epcglobal:cbv:mda#postalCode">10003-
1502</attribute>
                <attribute id="urn:epcglobal:cbv:mda#countryCode">US</attribute>
            </VocabularyElement>
        </VocabularyElementList>
    </Vocabulary>
</VocabularyList>
</EPCISMasterData>
</extension>
<gslushc:dscsaTransactionStatement>
    <gslushc:affirmTransactionStatement>true</gslushc:affirmTransactionStatement>
    <gslushc:legalNotice>Seller has complied with each applicable subsection of FDCA Sec.
581 (27) (A) - (G).</gslushc:legalNotice>
</gslushc:dscsaTransactionStatement>
</EPCISHeader>
<EPCISBody>
    <EventList>
        <!-- Transaction Information (TI) -->
        <ObjectEvent>
            <eventTime>2014-04-01T10:11:12Z</eventTime>
            <eventTimeZoneOffset>-05:00</eventTimeZoneOffset>
            <epcList/>
            <action>OBSERVE</action>

```

```

<bizStep>urn:epcglobal:cbv:bizstep:shipping</bizStep>
<disposition>urn:epcglobal:cbv:disp:in_transit</disposition>
<readPoint>
  <id>urn:epc:id:sgln:032468.000000.0</id>
</readPoint>
<extension>
  <quantityList>
    <quantityElement>
      <epcClass>urn:epc:class:lgtn:030000.0000001.L1</epcClass>
      <quantity>100</quantity>
    </quantityElement>
  </quantityList>
  <sourceList>
    <source
type="urn:epcglobal:cbv:sdt:owning_party">urn:epc:id:sgln:032468.000000.0</source>
    </sourceList>
  <destinationList>
    <destination
type="urn:epcglobal:cbv:sdt:owning_party">urn:epc:id:sgln:0614141.00000.0</destination>
    </destinationList>
  </extension>
</ObjectEvent>
</EventList>
</EPCISBody>
</epcis:EPCISDocument>

```

11.2 Sample XML: CLP as the Designated DSCSA Transaction Owner, W1 → D

Reference File: <https://resources.gs1us.org/Portals/0/xml/LotChoreo-CoLicensedPartner-Example-W1toD.xml>

```

<?xml version="1.0" encoding="UTF-8" standalone="yes"?>
<!-- Lot Choreography End to End Examples: CO-LICENSE PARTNER - EXAMPLE 1:
      CO-LICENSED PARTNER (CLP) AS THE DESIGNATED DSCSA TRANSACTION OWNER, W1->D  -->
<epcis:EPCISDocument xmlns:cbvmda="urn:epcglobal:cbv:mda"
xmlns:sbdh="http://www.unece.org/cefact/namespaces/StandardBusinessDocumentHeader"
xmlns:gslushc="http://epcis.gs1us.org/hc/ns" xmlns:epcis="urn:epcglobal:epcis:xsd:1"
schemaVersion="1.2" xsi:schemaLocation="urn:epcglobal:epcis:xsd:1 EPCglobal-epcis-1_2.xsd"
xmlns:xsi="http://www.w3.org/2001/XMLSchema-instance" creationDate="2014-05-30T15:14:27.574-
04:00">
  <EPCISHeader>
    <sbdh:StandardBusinessDocumentHeader>
      <sbdh:HeaderVersion>1.0</sbdh:HeaderVersion>
      <sbdh:Sender>
        <sbdh:Identifier
Authority="SGLN">urn:epc:id:sgln:0614141.00000.0</sbdh:Identifier>
      </sbdh:Sender>
      <sbdh:Receiver>
        <sbdh:Identifier
Authority="SGLN">urn:epc:id:sgln:5012345.00000.0</sbdh:Identifier>
      </sbdh:Receiver>
      <sbdh:DocumentIdentification>
        <sbdh:Standard>EPCglobal</sbdh:Standard>
        <sbdh:TypeVersion>1.0</sbdh:TypeVersion>
        <sbdh:InstanceIdentifier>1234567890</sbdh:InstanceIdentifier>
        <sbdh:Type>Events</sbdh:Type>
        <sbdh:CreationDateAndTime>2014-05-30T15:14:27.574-04:00</sbdh:CreationDateAndTime>
      </sbdh:DocumentIdentification>
    </sbdh:StandardBusinessDocumentHeader>
  <extension>

```



```

<EPCISMasterData>
  <VocabularyList>
    <Vocabulary type="urn:epcglobal:epcis:vtype:EPCClass">
      <VocabularyElementList>
        <VocabularyElement id="urn:epc:idpat:sgtin:030000.0000001.*">
          <attribute
id="urn:epcglobal:cbv:mda#additionalTradeItemIdentification">0000000001</attribute>
          <attribute
id="urn:epcglobal:cbv:mda#additionalTradeItemIdentificationTypeCode">FDA_NDC_11</attribute>
          <attribute
id="urn:epcglobal:cbv:mda#regulatedProductName">Epcistra</attribute>
          <attribute
id="urn:epcglobal:cbv:mda#manufacturerOfTradeItemPartyName">GS1 Pharma LLC</attribute>
          <attribute id="urn:epcglobal:cbv:mda#dosageFormType">PILL</attribute>
          <attribute
id="urn:epcglobal:cbv:mda#strengthDescription">100mg</attribute>
          <attribute id="urn:epcglobal:cbv:mda#netContentDescription">500
pills</attribute>
        </VocabularyElement>
      </VocabularyElementList>
    </Vocabulary>
    <Vocabulary type="urn:epcglobal:epcis:vtype:Location">
      <VocabularyElementList>
        <VocabularyElement id="urn:epc:id:sgln:030000.000000.0">
          <attribute id="urn:epcglobal:cbv:mda#name">GS1 Pharma LLC</attribute>
          <attribute id="urn:epcglobal:cbv:mda#streetAddressOne">1295 S George
Ave</attribute>
          <attribute id="urn:epcglobal:cbv:mda#streetAddressTwo">Room
378</attribute>
          <attribute id="urn:epcglobal:cbv:mda#city">Washington</attribute>
          <attribute id="urn:epcglobal:cbv:mda#state">DC</attribute>
          <attribute id="urn:epcglobal:cbv:mda#postalCode">12345-
6789</attribute>
          <attribute id="urn:epcglobal:cbv:mda#countryCode">US</attribute>
        </VocabularyElement>
        <VocabularyElement id="urn:epc:id:sgln:032468.000000.0">
          <attribute id="urn:epcglobal:cbv:mda#name">GS1 Biotech
LLC</attribute>
          <attribute id="urn:epcglobal:cbv:mda#streetAddressOne">1295 S
Technology Ct</attribute>
          <attribute id="urn:epcglobal:cbv:mda#streetAddressTwo">Room
412</attribute>
          <attribute id="urn:epcglobal:cbv:mda#city">Cambridge</attribute>
          <attribute id="urn:epcglobal:cbv:mda#state">MA</attribute>
          <attribute id="urn:epcglobal:cbv:mda#postalCode">02138</attribute>
          <attribute id="urn:epcglobal:cbv:mda#countryCode">US</attribute>
        </VocabularyElement>
        <VocabularyElement id="urn:epc:id:sgln:0614141.00000.0">
          <attribute id="urn:epcglobal:cbv:mda#name">GS1 Drug Distro
LLC</attribute>
          <attribute id="urn:epcglobal:cbv:mda#streetAddressOne">230 Park Ave
S</attribute>
          <attribute id="urn:epcglobal:cbv:mda#city">New York</attribute>
          <attribute id="urn:epcglobal:cbv:mda#state">NY</attribute>
          <attribute id="urn:epcglobal:cbv:mda#postalCode">10003-
1502</attribute>
          <attribute id="urn:epcglobal:cbv:mda#countryCode">US</attribute>
        </VocabularyElement>
        <VocabularyElement id="urn:epc:id:sgln:5012345.00000.0">
          <attribute id="urn:epcglobal:cbv:mda#name">GS1 Pere et Fils
Pharmacy</attribute>

```

```

        <attribute id="urn:epcglobal:cbv:mda#streetAddressOne">1313
Mockingbird Lane</attribute>
        <attribute id="urn:epcglobal:cbv:mda#city">Paris</attribute>
        <attribute id="urn:epcglobal:cbv:mda#state">TX</attribute>
        <attribute id="urn:epcglobal:cbv:mda#postalCode">76543</attribute>
        <attribute id="urn:epcglobal:cbv:mda#countryCode">US</attribute>
    </VocabularyElement>
</VocabularyElementList>
</Vocabulary>
</VocabularyList>
</EPCISMasterData>
</extension>
<gslushc:dscsaTransactionStatement>
    <gslushc:affirmTransactionStatement>true</gslushc:affirmTransactionStatement>
    <gslushc:legalNotice>Seller has complied with each applicable subsection of FDCA Sec.
581(27)(A)-(G). As indicated below, product was purchased directly from the manufacturer,
manufacturer's exclusive distributor or repackager who purchased directly from a
manufacturer.</gslushc:legalNotice>
    </gslushc:dscsaTransactionStatement>
</EPCISHeader>
<EPCISBody>
    <EventList>
        <!-- Transaction History (TH) -->
        <ObjectEvent>
            <eventTime>1970-01-01T00:00:00.000Z</eventTime>
            <eventTimeZoneOffset>+00:00</eventTimeZoneOffset>
            <epcList/>
            <action>OBSERVE</action>
            <bizStep>urn:epcglobal:cbv:bizstep:shipping</bizStep>
            <disposition>urn:epcglobal:cbv:disp:in_transit</disposition>
            <readPoint>
                <id>urn:epc:id:sgln:032468.000000.0</id>
            </readPoint>
            <extension>
                <quantityList>
                    <quantityElement>
                        <epcClass>urn:epc:idpat:sgtin:030000.0000001.*</epcClass>
                        <quantity>50</quantity>
                    </quantityElement>
                </quantityList>
                <sourceList>
                    <source
type="urn:epcglobal:cbv:sdt:owning_party">urn:epc:id:sgln:032468.000000.0</source>
                </sourceList>
                <destinationList>
                    <destination
type="urn:epcglobal:cbv:sdt:owning_party">urn:epc:id:sgln:0614141.00000.0</destination>
                </destinationList>
            </extension>
        </ObjectEvent>
        <!-- Transaction Information (TI) -->
        <ObjectEvent>
            <eventTime>2014-04-05T11:00:00.000-04:00</eventTime>
            <eventTimeZoneOffset>-04:00</eventTimeZoneOffset>
            <epcList/>
            <action>OBSERVE</action>
            <bizStep>urn:epcglobal:cbv:bizstep:shipping</bizStep>
            <disposition>urn:epcglobal:cbv:disp:in_transit</disposition>
            <readPoint>
                <id>urn:epc:id:sgln:0614141.00000.0</id>
            </readPoint>

```

```

    <extension>
      <quantityList>
        <quantityElement>
          <epcClass>urn:epc:idpat:sgtin:030000.0000001.*</epcClass>
          <quantity>50</quantity>
        </quantityElement>
      </quantityList>
      <sourceList>
        <source
type="urn:epcglobal:cbv:sdt:owning_party">urn:epc:id:sgln:0614141.00000.0</source>
        </sourceList>
      <destinationList>
        <destination
type="urn:epcglobal:cbv:sdt:owning_party">urn:epc:id:sgln:5012345.00000.0</destination>
        </destinationList>
      </extension>
      <gslushc:directPurchase value="true"/>
    </ObjectEvent>
  </EventList>
</EPCISBody>
</epcis:EPCISDocument>

```

11.3 Sample XML: Manufacturer as the Designated DSCSA Transaction Owner, M → W1



Note: This example reflects the manufacturer as the designated manufacturer for DSCSA purposes and the the party responsible for providing the TI, TH and TS. Because the DSCSA transaction begins with the manufacturer, the message content of the M → W1 transaction in this example is identical to the content of the M → W1 transaction in the [Direct Purchase Example 1](#).

Reference File: <https://resources.gs1us.org/Portals/0/xml/LotChoreo-CoLicensedPartner Example-MfgAsDesignatedOwner MtoW1.xml>

```

<?xml version="1.0" encoding="UTF-8" standalone="yes"?>
<!-- Lot Choreography End to End Examples: CO-LICENSE PARTNER - EXAMPLE 1:
      MANUFACTURER AS THE DESIGNATED TRANSACTION OWNER, M->W1 -->
<!-- The M->W1 transaction in this example is identical to the M->W1 content for Direct
Purchase Example1 -->
<epcis:EPCISDocument xmlns:cbvmda="urn:epcglobal:cbv:mda"
xmlns:sbdh="http://www.unece.org/cefact/namespaces/StandardBusinessDocumentHeader"
xmlns:gslushc="http://epcis.gslus.org/hc/ns" xmlns:epcis="urn:epcglobal:epcis:xsd:1"
schemaVersion="1.2" xsi:schemaLocation="urn:epcglobal:epcis:xsd:1 EPCglobal-epcis-1_2.xsd"
xmlns:xsi="http://www.w3.org/2001/XMLSchema-instance" creationDate="2014-05-30T15:14:27.574-
04:00">
  <EPCISHeader>
    <sbdh:StandardBusinessDocumentHeader>
      <sbdh:HeaderVersion>1.0</sbdh:HeaderVersion>
      <sbdh:Sender>
        <sbdh:Identifier
Authority="SGLN">urn:epc:id:sgln:030000.000000.0</sbdh:Identifier>
      </sbdh:Sender>
      <sbdh:Receiver>
        <sbdh:Identifier
Authority="SGLN">urn:epc:id:sgln:0614141.00000.0</sbdh:Identifier>
      </sbdh:Receiver>
      <sbdh:DocumentIdentification>
        <sbdh:Standard>EPCglobal</sbdh:Standard>
        <sbdh:TypeVersion>1.0</sbdh:TypeVersion>

```

```

    <sbdh:InstanceIdentifier>1234567890</sbdh:InstanceIdentifier>
    <sbdh:Type>Events</sbdh:Type>
    <sbdh:CreationDateAndTime>2014-05-30T15:14:27.574-04:00</sbdh:CreationDateAndTime>
  </sbdh:DocumentIdentification>
</sbdh:StandardBusinessDocumentHeader>
<extension>
  <EPCISMasterData>
    <VocabularyList>
      <Vocabulary type="urn:epcglobal:epcis:vtype:EPCClass">
        <VocabularyElementList>
          <VocabularyElement id="urn:epc:class:lgtn:030000.0000001.L1">
            <attribute id="urn:epcglobal:cbv:mda#itemExpirationDate">2015-10-
31</attribute>
            </VocabularyElement>
            <VocabularyElement id="urn:epc:idpat:sgtin:030000.0000001.*">
              <attribute
id="urn:epcglobal:cbv:mda#additionalTradeItemIdentification">00000000001</attribute>
              <attribute
id="urn:epcglobal:cbv:mda#additionalTradeItemIdentificationTypeCode">FDA_NDC_11</attribute>
              <attribute
id="urn:epcglobal:cbv:mda#regulatedProductName">Epcistra</attribute>
              <attribute
id="urn:epcglobal:cbv:mda#manufacturerOfTradeItemPartyName">GS1 Pharma LLC</attribute>
              <attribute id="urn:epcglobal:cbv:mda#dosageFormType">PILL</attribute>
              <attribute
id="urn:epcglobal:cbv:mda#strengthDescription">100mg</attribute>
              <attribute id="urn:epcglobal:cbv:mda#netContentDescription">500
pills</attribute>
            </VocabularyElement>
          </VocabularyElementList>
        </Vocabulary>
        <Vocabulary type="urn:epcglobal:epcis:vtype:Location">
          <VocabularyElementList>
            <VocabularyElement id="urn:epc:id:sgln:030000.000000.0">
              <attribute id="urn:epcglobal:cbv:mda#name">GS1 Pharma LLC</attribute>
              <attribute id="urn:epcglobal:cbv:mda#streetAddressOne">1295 S George
Ave</attribute>
              <attribute id="urn:epcglobal:cbv:mda#streetAddressTwo">Room
378</attribute>
              <attribute id="urn:epcglobal:cbv:mda#city">Washington</attribute>
              <attribute id="urn:epcglobal:cbv:mda#state">DC</attribute>
              <attribute id="urn:epcglobal:cbv:mda#postalCode">12345-
6789</attribute>
              <attribute id="urn:epcglobal:cbv:mda#countryCode">US</attribute>
            </VocabularyElement>
            <VocabularyElement id="urn:epc:id:sgln:0614141.00000.0">
              <attribute id="urn:epcglobal:cbv:mda#name">GS1 Drug Distro
LLC</attribute>
              <attribute id="urn:epcglobal:cbv:mda#streetAddressOne">230 Park Ave
S</attribute>
              <attribute id="urn:epcglobal:cbv:mda#city">New York</attribute>
              <attribute id="urn:epcglobal:cbv:mda#state">NY</attribute>
              <attribute id="urn:epcglobal:cbv:mda#postalCode">10003-
1502</attribute>
              <attribute id="urn:epcglobal:cbv:mda#countryCode">US</attribute>
            </VocabularyElement>
          </VocabularyElementList>
        </Vocabulary>
      </VocabularyList>
    </EPCISMasterData>
  </extension>

```

```

    <gslushc:dscsaTransactionStatement>
      <gslushc:affirmTransactionStatement>true</gslushc:affirmTransactionStatement>
      <gslushc:legalNotice>Seller has complied with each applicable subsection of FDCA Sec.
581 (27) (A) - (G).</gslushc:legalNotice>
    </gslushc:dscsaTransactionStatement>
  </EPCISHeader>
  <EPCISBody>
    <EventList>
      <!-- Transaction Information (TI) -->
      <ObjectEvent>
        <eventTime>2014-04-01T10:11:12Z</eventTime>
        <eventTimeZoneOffset>-05:00</eventTimeZoneOffset>
        <epcList/>
        <action>OBSERVE</action>
        <bizStep>urn:epcglobal:cbv:bizstep:shipping</bizStep>
        <disposition>urn:epcglobal:cbv:disp:in_transit</disposition>
        <readPoint>
          <id>urn:epc:id:sgln:030000.000000.0</id>
        </readPoint>
        <extension>
          <quantityList>
            <quantityElement>
              <epcClass>urn:epc:class:lgtn:030000.0000001.L1</epcClass>
              <quantity>100</quantity>
            </quantityElement>
          </quantityList>
          <sourceList>
            <source
type="urn:epcglobal:cbv:sdt:owning_party">urn:epc:id:sgln:030000.000000.0</source>
          </sourceList>
          <destinationList>
            <destination
type="urn:epcglobal:cbv:sdt:owning_party">urn:epc:id:sgln:0614141.00000.0</destination>
          </destinationList>
        </extension>
      </ObjectEvent>
    </EventList>
  </EPCISBody>
</epcis:EPCISDocument>

```

11.4 Sample XML: Manufacturer as the Designated DSCSA Transaction Owner, W1 → D



Note: The message content of the DSCSA transaction for W1 → D in this example is identical to the content of the W1 → D in the [Direct Purchase Example 1](#).

Reference File: <https://resources.gs1us.org/Portals/0/xml/LotChoreo-CoLicensedPartner Example-MfgAsDesignatedOwner W1toD.xml>

```

<?xml version="1.0" encoding="UTF-8" standalone="yes"?>
<!-- Lot Choreography End to End Examples: CO-LICENSE PARTNER - EXAMPLE 1:
MANUFACTURER AS THE DESIGNATED TRANSACTION OWNER, W1->D -->
<!-- The W1->D transaction in this example is identical to the W1->D content for Direct
Purchase Example1 -->
<epcis:EPCISDocument xmlns:cbvmda="urn:epcglobal:cbv:mda"
xmlns:sbdh="http://www.unece.org/cefact/namespaces/StandardBusinessDocumentHeader"
xmlns:gslushc="http://epcis.gs1us.org/hc/ns" xmlns:epcis="urn:epcglobal:epcis:xsd:1"
schemaVersion="1.2" xsi:schemaLocation="urn:epcglobal:epcis:xsd:1 EPCglobal-epcis-1_2.xsd"

```

```

xmlns:xsi="http://www.w3.org/2001/XMLSchema-instance" creationDate="2014-05-30T15:14:27.574-
04:00">
  <EPCISHeader>
    <sbdh:StandardBusinessDocumentHeader>
      <sbdh:HeaderVersion>1.0</sbdh:HeaderVersion>
      <sbdh:Sender>
        <sbdh:Identifier
Authority="SGLN">urn:epc:id:sgln:0614141.00000.0</sbdh:Identifier>
        </sbdh:Sender>
      <sbdh:Receiver>
        <sbdh:Identifier
Authority="SGLN">urn:epc:id:sgln:5012345.00000.0</sbdh:Identifier>
        </sbdh:Receiver>
      <sbdh:DocumentIdentification>
        <sbdh:Standard>EPCglobal</sbdh:Standard>
        <sbdh:TypeVersion>1.0</sbdh:TypeVersion>
        <sbdh:InstanceIdentifier>1234567890</sbdh:InstanceIdentifier>
        <sbdh:Type>Events</sbdh:Type>
        <sbdh:CreationDateAndTime>2014-05-30T15:14:27.574-04:00</sbdh:CreationDateAndTime>
      </sbdh:DocumentIdentification>
    </sbdh:StandardBusinessDocumentHeader>
    <extension>
      <EPCISMasterData>
        <VocabularyList>
          <Vocabulary type="urn:epcglobal:epcis:vtype:EPCClass">
            <VocabularyElementList>
              <VocabularyElement id="urn:epc:idpat:sgtin:030000.0000001.*">
                <attribute
id="urn:epcglobal:cbv:mda#additionalTradeItemIdentification">00000000001</attribute>
                <attribute
id="urn:epcglobal:cbv:mda#additionalTradeItemIdentificationTypeCode">FDA_NDC_11</attribute>
                <attribute
id="urn:epcglobal:cbv:mda#regulatedProductName">Epcistra</attribute>
                <attribute
id="urn:epcglobal:cbv:mda#manufacturerOfTradeItemPartyName">GS1 Pharma LLC</attribute>
                <attribute id="urn:epcglobal:cbv:mda#dosageFormType">PILL</attribute>
                <attribute
id="urn:epcglobal:cbv:mda#strengthDescription">100mg</attribute>
                <attribute id="urn:epcglobal:cbv:mda#netContentDescription">500
pills</attribute>
              </VocabularyElement>
            </VocabularyElementList>
          </Vocabulary>
          <Vocabulary type="urn:epcglobal:epcis:vtype:Location">
            <VocabularyElementList>
              <VocabularyElement id="urn:epc:id:sgln:030000.000000.0">
                <attribute id="urn:epcglobal:cbv:mda#name">GS1 Pharma LLC</attribute>
                <attribute id="urn:epcglobal:cbv:mda#streetAddressOne">1295 S George
Ave</attribute>
                <attribute id="urn:epcglobal:cbv:mda#streetAddressTwo">Room
378</attribute>
                <attribute id="urn:epcglobal:cbv:mda#city">Washington</attribute>
                <attribute id="urn:epcglobal:cbv:mda#state">DC</attribute>
                <attribute id="urn:epcglobal:cbv:mda#postalCode">12345-
6789</attribute>
                <attribute id="urn:epcglobal:cbv:mda#countryCode">US</attribute>
              </VocabularyElement>
              <VocabularyElement id="urn:epc:id:sgln:0614141.00000.0">
                <attribute id="urn:epcglobal:cbv:mda#name">GS1 Drug Distro
LLC</attribute>

```

```

        <attribute id="urn:epcglobal:cbv:mda#streetAddressOne">230 Park Ave
S</attribute>
        <attribute id="urn:epcglobal:cbv:mda#city">New York</attribute>
        <attribute id="urn:epcglobal:cbv:mda#state">NY</attribute>
        <attribute id="urn:epcglobal:cbv:mda#postalCode">10003-
1502</attribute>
        <attribute id="urn:epcglobal:cbv:mda#countryCode">US</attribute>
</VocabularyElement>
<VocabularyElement id="urn:epc:id:sgln:5012345.00000.0">
  <attribute id="urn:epcglobal:cbv:mda#name">GS1 Pere et Fils
Pharmacy</attribute>
  <attribute id="urn:epcglobal:cbv:mda#streetAddressOne">1313
Mockingbird Lane</attribute>
  <attribute id="urn:epcglobal:cbv:mda#city">Paris</attribute>
  <attribute id="urn:epcglobal:cbv:mda#state">TX</attribute>
  <attribute id="urn:epcglobal:cbv:mda#postalCode">76543</attribute>
  <attribute id="urn:epcglobal:cbv:mda#countryCode">US</attribute>
</VocabularyElement>
</VocabularyElementList>
</Vocabulary>
</VocabularyList>
</EPCISMasterData>
</extension>
<gslushc:dscsaTransactionStatement>
  <gslushc:affirmTransactionStatement>true</gslushc:affirmTransactionStatement>
  <gslushc:legalNotice>Seller has complied with each applicable subsection of FDCA Sec.
581(27)(A)-(G). As indicated below, product was purchased directly from the manufacturer,
manufacturer's exclusive distributor or repackager who purchased directly from a
manufacturer.</gslushc:legalNotice>
</gslushc:dscsaTransactionStatement>
</EPCISHeader>
<EPCISBody>
  <EventList>
    <!-- Transaction History (TH) -->
    <ObjectEvent>
      <eventTime>1970-01-01T00:00:00.000Z</eventTime>
      <eventTimeZoneOffset>+00:00</eventTimeZoneOffset>
      <epcList/>
      <action>OBSERVE</action>
      <bizStep>urn:epcglobal:cbv:bizstep:shipping</bizStep>
      <disposition>urn:epcglobal:cbv:disp:in_transit</disposition>
      <readPoint>
        <id>urn:epc:id:sgln:030000.000000.0</id>
      </readPoint>
      <extension>
        <quantityList>
          <quantityElement>
            <epcClass>urn:epc:idpat:sgtin:030000.0000001.*</epcClass>
            <quantity>50</quantity>
          </quantityElement>
        </quantityList>
        <sourceList>
          <source
type="urn:epcglobal:cbv:sdt:owning_party">urn:epc:id:sgln:030000.000000.0</source>
        </sourceList>
        <destinationList>
          <destination
type="urn:epcglobal:cbv:sdt:owning_party">urn:epc:id:sgln:0614141.00000.0</destination>
        </destinationList>
      </extension>
    </ObjectEvent>
  </EventList>
</EPCISBody>
</EPCISHeader>
</EPCISMessage>

```

```

<!-- Transaction Information (TI) -->
<ObjectEvent>
  <eventTime>2014-04-05T11:00:00.000-04:00</eventTime>
  <eventTimeZoneOffset>-04:00</eventTimeZoneOffset>
  <epcList/>
  <action>OBSERVE</action>
  <bizStep>urn:epcglobal:cbv:bizstep:shipping</bizStep>
  <disposition>urn:epcglobal:cbv:disp:in_transit</disposition>
  <readPoint>
    <id>urn:epc:id:sgln:0614141.00000.0</id>
  </readPoint>
  <extension>
    <quantityList>
      <quantityElement>
        <epcClass>urn:epc:idpat:sgtin:030000.0000001.*</epcClass>
        <quantity>50</quantity>
      </quantityElement>
    </quantityList>
    <sourceList>
      <source
type="urn:epcglobal:cbv:sdt:owning_party">urn:epc:id:sgln:0614141.00000.0</source>
    </sourceList>
    <destinationList>
      <destination
type="urn:epcglobal:cbv:sdt:owning_party">urn:epc:id:sgln:5012345.00000.0</destination>
    </destinationList>
  </extension>
  <gslushc:directPurchase value="true"/>
</ObjectEvent>
</EventList>
</EPCISBody>
</epcis:EPCISDocument>

```

12 Contract Packaging Scenario – Example 1

In this example, the manufacturer sends semi-finished goods to the contract packager who completes the packaging process and sends back the finished goods back to the manufacturer.

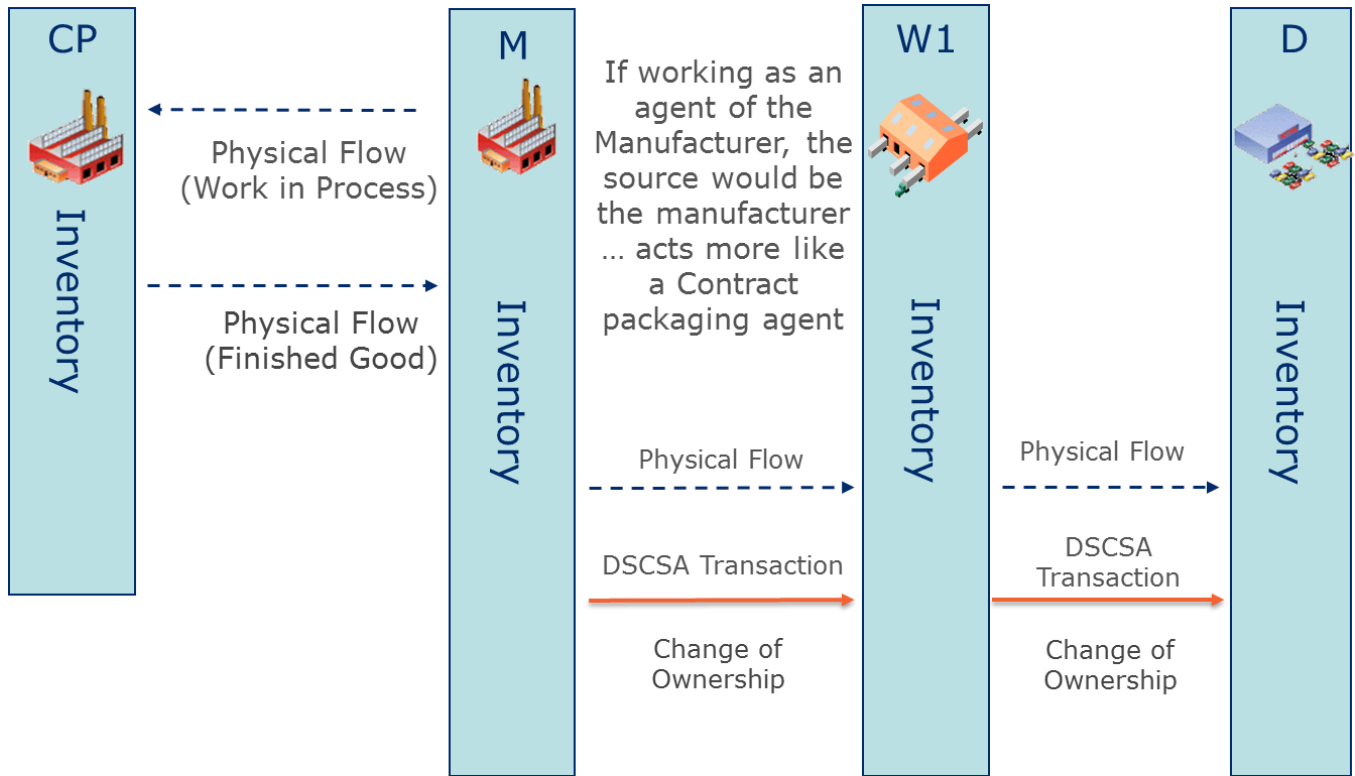

12.1 Sample XML: M → W1

 **Note:** Because the manufacturer is the DSCSA transaction owner, the DSCSA transaction begins with the manufacturer. Therefore, the message content of the M → W1 transaction in this example is identical to the content of the M → W1 transaction in the [Direct Purchase Example 1](#).

Reference File: <https://resources.gs1us.org/Portals/0/xml/LotChoreo-Contract Packaging Example-MtoW1.xml>

```
<?xml version="1.0" encoding="UTF-8" standalone="yes"?>
<!-- Lot Choreography End to End Examples: CONTRACT PACKAGING - EXAMPLE 1: M->W1 -->
<!-- The M->W1 transaction in this example is identical to the M->W1 content for Direct
Purchase Example1 -->
<epcis:EPCISDocument xmlns:cbvmda="urn:epcglobal:cbv:mda"
xmlns:sbdh="http://www.unece.org/cefact/namespaces/StandardBusinessDocumentHeader"
xmlns:gs1ushc="http://epcis.gs1us.org/hc/ns" xmlns:epcis="urn:epcglobal:epcis:xsd:1"
schemaVersion="1.2" xsi:schemaLocation="urn:epcglobal:epcis:xsd:1 EPCglobal-epcis-1_2.xsd"
xmlns:xsi="http://www.w3.org/2001/XMLSchema-instance" creationDate="2014-05-30T15:14:27.574-
04:00">
  <EPCISHeader>
    <sbdh:StandardBusinessDocumentHeader>
      <sbdh:HeaderVersion>1.0</sbdh:HeaderVersion>
      <sbdh:Sender>
        <sbdh:Identifier
Authority="SGLN">urn:epc:id:sgln:030000.000000.0</sbdh:Identifier>
        </sbdh:Sender>
        <sbdh:Receiver>
          <sbdh:Identifier
Authority="SGLN">urn:epc:id:sgln:0614141.00000.0</sbdh:Identifier>
          </sbdh:Receiver>
          <sbdh:DocumentIdentification>
            <sbdh:Standard>EPCglobal</sbdh:Standard>
            <sbdh:TypeVersion>1.0</sbdh:TypeVersion>
            <sbdh:InstanceIdentifier>1234567890</sbdh:InstanceIdentifier>
            <sbdh:Type>Events</sbdh:Type>
            <sbdh:CreationDateAndTime>2014-05-30T15:14:27.574-04:00</sbdh:CreationDateAndTime>
          </sbdh:DocumentIdentification>
        </sbdh:StandardBusinessDocumentHeader>
        <extension>
          <EPCISMasterData>
            <VocabularyList>
              <Vocabulary type="urn:epcglobal:epcis:vtype:EPCClass">
                <VocabularyElementList>
                  <VocabularyElement id="urn:epc:class:lgtin:030000.0000001.L1">
                    <attribute id="urn:epcglobal:cbv:mda#itemExpirationDate">2015-10-
31</attribute>
                  </VocabularyElement>
                  <VocabularyElement id="urn:epc:idpat:sgtin:030000.0000001.*">
                    <attribute
id="urn:epcglobal:cbv:mda#additionalTradeItemIdentification">00000000001</attribute>
                    <attribute
id="urn:epcglobal:cbv:mda#additionalTradeItemIdentificationTypeCode">FDA_NDC_11</attribute>
                    <attribute
id="urn:epcglobal:cbv:mda#regulatedProductName">Epcistra</attribute>
                    <attribute
id="urn:epcglobal:cbv:mda#manufacturerOfTradeItemPartyName">GS1 Pharma LLC</attribute>
                    <attribute id="urn:epcglobal:cbv:mda#dosageFormType">PILL</attribute>
                    <attribute
id="urn:epcglobal:cbv:mda#strengthDescription">100mg</attribute>
```



```

        <sourceList>
          <source
type="urn:epcglobal:cbv:sdt:owning_party">urn:epc:id:sgln:030000.000000.0</source>
        </sourceList>
        <destinationList>
          <destination
type="urn:epcglobal:cbv:sdt:owning_party">urn:epc:id:sgln:0614141.00000.0</destination>
        </destinationList>
      </extension>
    </ObjectEvent>
  </EventList>
</EPCISBody>
</epcis:EPCISDocument>

```

12.2 Sample XML: W1 → D



Note: The message content of the DSCSA transaction for W1 → D in this example is identical to the content of the W1 → D in the [Direct Purchase Example 1](#).

Reference File: <https://resources.gs1us.org/Portals/0/xml/LotChoreo-Contract Packaging Example-W1toD.xml>

```

<?xml version="1.0" encoding="UTF-8" standalone="yes"?>
<!-- Lot Choreography End to End Examples: CONTRACT PACKAGING - EXAMPLE 1: W1->D -->
<!-- The W1->D transaction in this example is identical to the W1->D content for Direct
Purchase Example1 -->
<epcis:EPCISDocument xmlns:cbvmda="urn:epcglobal:cbv:mda"
xmlns:sbdh="http://www.unece.org/cefact/namespaces/StandardBusinessDocumentHeader"
xmlns:gslushc="http://epcis.gsln.org/hc/ns" xmlns:epcis="urn:epcglobal:epcis:xsd:1"
schemaVersion="1.2" xsi:schemaLocation="urn:epcglobal:epcis:xsd:1 EPCglobal-epcis-1_2.xsd"
xmlns:xsi="http://www.w3.org/2001/XMLSchema-instance" creationDate="2014-05-30T15:14:27.574-
04:00">
  <EPCISHeader>
    <sbdh:StandardBusinessDocumentHeader>
      <sbdh:HeaderVersion>1.0</sbdh:HeaderVersion>
      <sbdh:Sender>
        <sbdh:Identifier
Authority="SGLN">urn:epc:id:sgln:0614141.00000.0</sbdh:Identifier>
      </sbdh:Sender>
      <sbdh:Receiver>
        <sbdh:Identifier
Authority="SGLN">urn:epc:id:sgln:5012345.00000.0</sbdh:Identifier>
      </sbdh:Receiver>
      <sbdh:DocumentIdentification>
        <sbdh:Standard>EPCglobal</sbdh:Standard>
        <sbdh:TypeVersion>1.0</sbdh:TypeVersion>
        <sbdh:InstanceIdentifier>1234567890</sbdh:InstanceIdentifier>
        <sbdh:Type>Events</sbdh:Type>
        <sbdh:CreationDateAndTime>2014-05-30T15:14:27.574-04:00</sbdh:CreationDateAndTime>
      </sbdh:DocumentIdentification>
    </sbdh:StandardBusinessDocumentHeader>
    <extension>
      <EPCISMasterData>
        <VocabularyList>
          <Vocabulary type="urn:epcglobal:epcis:vtype:EPCClass">
            <VocabularyElementList>
              <VocabularyElement id="urn:epc:idpat:sgtin:030000.0000001.*">
                <attribute
id="urn:epcglobal:cbv:mda#additionalTradeItemIdentification">0000000001</attribute>

```

```

        <attribute
id="urn:epcglobal:cbv:mda#additionalTradeItemIdentificationTypeCode">FDA_NDC_11</attribute>
        <attribute
id="urn:epcglobal:cbv:mda#regulatedProductName">Epcistra</attribute>
        <attribute
id="urn:epcglobal:cbv:mda#manufacturerOfTradeItemPartyName">GS1 Pharma LLC</attribute>
        <attribute id="urn:epcglobal:cbv:mda#dosageFormType">PILL</attribute>
        <attribute
id="urn:epcglobal:cbv:mda#strengthDescription">100mg</attribute>
        <attribute id="urn:epcglobal:cbv:mda#netContentDescription">500
pills</attribute>
    </VocabularyElement>
</VocabularyElementList>
</Vocabulary>
<Vocabulary type="urn:epcglobal:epcis:vtype:Location">
    <VocabularyElementList>
        <VocabularyElement id="urn:epc:id:sgln:030000.000000.0">
            <attribute id="urn:epcglobal:cbv:mda#name">GS1 Pharma LLC</attribute>
            <attribute id="urn:epcglobal:cbv:mda#streetAddressOne">1295 S George
Ave</attribute>
            <attribute id="urn:epcglobal:cbv:mda#streetAddressTwo">Room
378</attribute>
            <attribute id="urn:epcglobal:cbv:mda#city">Washington</attribute>
            <attribute id="urn:epcglobal:cbv:mda#state">DC</attribute>
            <attribute id="urn:epcglobal:cbv:mda#postalCode">12345-
6789</attribute>
            <attribute id="urn:epcglobal:cbv:mda#countryCode">US</attribute>
        </VocabularyElement>
        <VocabularyElement id="urn:epc:id:sgln:0614141.000000.0">
            <attribute id="urn:epcglobal:cbv:mda#name">GS1 Drug Distro
LLC</attribute>
            <attribute id="urn:epcglobal:cbv:mda#streetAddressOne">230 Park Ave
S</attribute>
            <attribute id="urn:epcglobal:cbv:mda#city">New York</attribute>
            <attribute id="urn:epcglobal:cbv:mda#state">NY</attribute>
            <attribute id="urn:epcglobal:cbv:mda#postalCode">10003-
1502</attribute>
            <attribute id="urn:epcglobal:cbv:mda#countryCode">US</attribute>
        </VocabularyElement>
        <VocabularyElement id="urn:epc:id:sgln:5012345.000000.0">
            <attribute id="urn:epcglobal:cbv:mda#name">GS1 Pere et Fils
Pharmacy</attribute>
            <attribute id="urn:epcglobal:cbv:mda#streetAddressOne">1313
Mockingbird Lane</attribute>
            <attribute id="urn:epcglobal:cbv:mda#city">Paris</attribute>
            <attribute id="urn:epcglobal:cbv:mda#state">TX</attribute>
            <attribute id="urn:epcglobal:cbv:mda#postalCode">76543</attribute>
            <attribute id="urn:epcglobal:cbv:mda#countryCode">US</attribute>
        </VocabularyElement>
    </VocabularyElementList>
</Vocabulary>
</VocabularyList>
</EPCISMasterData>
</extension>
<gslushc:dscsaTransactionStatement>
    <gslushc:affirmTransactionStatement>true</gslushc:affirmTransactionStatement>
    <gslushc:legalNotice>Seller has complied with each applicable subsection of FDCA Sec.
581(27)(A)-(G). As indicated below, product was purchased directly from the manufacturer,
manufacturer's exclusive distributor or repackager who purchased directly from a
manufacturer.</gslushc:legalNotice>
</gslushc:dscsaTransactionStatement>

```

```

</EPCISHeader>
<EPCISBody>
  <EventList>
    <!-- Transaction History (TH) -->
    <ObjectEvent>
      <eventTime>1970-01-01T00:00:00.000Z</eventTime>
      <eventTimeZoneOffset>+00:00</eventTimeZoneOffset>
      <epcList/>
      <action>OBSERVE</action>
      <bizStep>urn:epcglobal:cbv:bizstep:shipping</bizStep>
      <disposition>urn:epcglobal:cbv:disp:in_transit</disposition>
      <readPoint>
        <id>urn:epc:id:sgln:030000.000000.0</id>
      </readPoint>
      <extension>
        <quantityList>
          <quantityElement>
            <epcClass>urn:epc:idpat:sgtin:030000.0000001.*</epcClass>
            <quantity>50</quantity>
          </quantityElement>
        </quantityList>
        <sourceList>
          <source
type="urn:epcglobal:cbv:sdt:owning_party">urn:epc:id:sgln:030000.000000.0</source>
          </sourceList>
        <destinationList>
          <destination
type="urn:epcglobal:cbv:sdt:owning_party">urn:epc:id:sgln:0614141.00000.0</destination>
          </destinationList>
        </extension>
      </ObjectEvent>
    <!-- Transaction Information (TI) -->
    <ObjectEvent>
      <eventTime>2014-04-05T11:00:00.000-04:00</eventTime>
      <eventTimeZoneOffset>-04:00</eventTimeZoneOffset>
      <epcList/>
      <action>OBSERVE</action>
      <bizStep>urn:epcglobal:cbv:bizstep:shipping</bizStep>
      <disposition>urn:epcglobal:cbv:disp:in_transit</disposition>
      <readPoint>
        <id>urn:epc:id:sgln:0614141.00000.0</id>
      </readPoint>
      <extension>
        <quantityList>
          <quantityElement>
            <epcClass>urn:epc:idpat:sgtin:030000.0000001.*</epcClass>
            <quantity>50</quantity>
          </quantityElement>
        </quantityList>
        <sourceList>
          <source
type="urn:epcglobal:cbv:sdt:owning_party">urn:epc:id:sgln:0614141.00000.0</source>
          </sourceList>
        <destinationList>
          <destination
type="urn:epcglobal:cbv:sdt:owning_party">urn:epc:id:sgln:5012345.00000.0</destination>
          </destinationList>
        <gslushc:directPurchase value="true"/>
      </extension>
    </ObjectEvent>
  </EventList>

```



```
</EPCISBody>  
</epcis:EPCISDocument>
```

13 Repackaging Scenario – Example 1

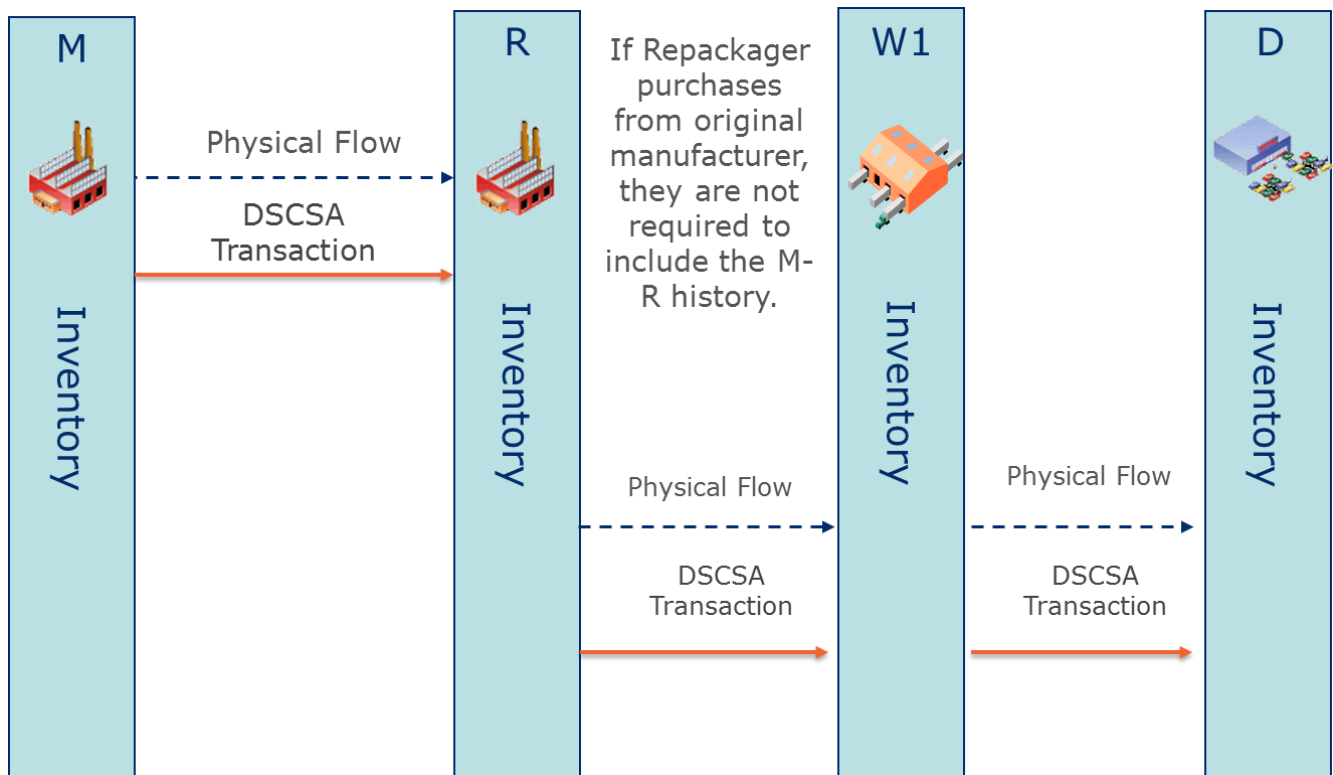

13.1 Sample XML: M → R

Reference File: <https://resources.gs1us.org/Portals/0/xml/LotChoreo-RePackaging Example1-MtoR.xml>

```
<?xml version="1.0" encoding="UTF-8" standalone="yes"?>
<!-- Lot Choreography End to End Examples: REPACKAGING - EXAMPLE 1: M->R -->
<epcis:EPCISDocument xmlns:cbvmda="urn:epcglobal:cbv:mda"
xmlns:sbdh="http://www.unece.org/cefact/namespaces/StandardBusinessDocumentHeader"
xmlns:gslushc="http://epcis.gs1us.org/hc/ns" xmlns:epcis="urn:epcglobal:epcis:xsd:1"
schemaVersion="1.2" xsi:schemaLocation="urn:epcglobal:epcis:xsd:1 EPCglobal-epcis-1_2.xsd"
xmlns:xsi="http://www.w3.org/2001/XMLSchema-instance" creationDate="2014-05-30T15:14:27.574-
04:00">
  <EPCISHeader>
    <sbdh:StandardBusinessDocumentHeader>
      <sbdh:HeaderVersion>1.0</sbdh:HeaderVersion>
      <sbdh:Sender>
        <sbdh:Identifier
Authority="SGLN">urn:epc:id:sgln:030000.000000.0</sbdh:Identifier>
        </sbdh:Sender>
      <sbdh:Receiver>
        <sbdh:Identifier
Authority="SGLN">urn:epc:id:sgln:0353579.00001.0</sbdh:Identifier>
        </sbdh:Receiver>
      <sbdh:DocumentIdentification>
        <sbdh:Standard>EPCglobal</sbdh:Standard>
        <sbdh:TypeVersion>1.0</sbdh:TypeVersion>
        <sbdh:InstanceIdentifier>1234567890</sbdh:InstanceIdentifier>
        <sbdh:Type>Events</sbdh:Type>
        <sbdh:CreationDateAndTime>2014-05-30T15:14:27.574-04:00</sbdh:CreationDateAndTime>
      </sbdh:DocumentIdentification>
    </sbdh:StandardBusinessDocumentHeader>
    <extension>
      <EPCISMasterData>
        <VocabularyList>
          <Vocabulary type="urn:epcglobal:epcis:vtype:EPCClass">
            <VocabularyElementList>
              <VocabularyElement id="urn:epc:class:lgtin:030000.0000001.L1">
                <attribute id="urn:epcglobal:cbv:mda#itemExpirationDate">2015-10-
31</attribute>
              </VocabularyElement>
              <VocabularyElement id="urn:epc:idpat:sgtin:030000.0000001.*">
                <attribute
id="urn:epcglobal:cbv:mda#additionalTradeItemIdentification">0000000001</attribute>
                <attribute
id="urn:epcglobal:cbv:mda#additionalTradeItemIdentificationTypeCode">FDA_NDC_11</attribute>
                <attribute
id="urn:epcglobal:cbv:mda#regulatedProductName">Epcistra</attribute>
                <attribute
id="urn:epcglobal:cbv:mda#manufacturerOfTradeItemPartyName">GS1 Pharma LLC</attribute>
                <attribute id="urn:epcglobal:cbv:mda#dosageFormType">PILL</attribute>
                <attribute
id="urn:epcglobal:cbv:mda#strengthDescription">100mg</attribute>
                <attribute id="urn:epcglobal:cbv:mda#netContentDescription">500
pills</attribute>
              </VocabularyElement>
            </VocabularyElementList>
          </Vocabulary>
          <Vocabulary type="urn:epcglobal:epcis:vtype:Location">
            <VocabularyElementList>
              <VocabularyElement id="urn:epc:id:sgln:030000.000000.0">
                <attribute id="urn:epcglobal:cbv:mda#name">GS1 Pharma LLC</attribute>
              </VocabularyElement>
            </VocabularyElementList>
          </Vocabulary>
        </EPCISMasterData>
      </extension>
    </EPCISHeader>
  </EPCISDocument>

```

```

Ave</attribute>
378</attribute>
6789</attribute>
LLC</attribute>
Ave</attribute>
10</attribute>
<attribute id="urn:epcglobal:cbv:mda#streetAddressOne">1295 S George
<attribute id="urn:epcglobal:cbv:mda#streetAddressTwo">Room
<attribute id="urn:epcglobal:cbv:mda#city">Washington</attribute>
<attribute id="urn:epcglobal:cbv:mda#state">DC</attribute>
<attribute id="urn:epcglobal:cbv:mda#postalCode">12345-
<attribute id="urn:epcglobal:cbv:mda#countryCode">US</attribute>
</VocabularyElement>
<VocabularyElement id="urn:epc:id:sgln:0353579.00001.0">
<attribute id="urn:epcglobal:cbv:mda#name">GS1 Repackager
<attribute id="urn:epcglobal:cbv:mda#streetAddressOne">201 Broadway
<attribute id="urn:epcglobal:cbv:mda#streetAddressTwo">Bldg
<attribute id="urn:epcglobal:cbv:mda#city">Cambridge</attribute>
<attribute id="urn:epcglobal:cbv:mda#state">MA</attribute>
<attribute id="urn:epcglobal:cbv:mda#postalCode">02138</attribute>
<attribute id="urn:epcglobal:cbv:mda#countryCode">US</attribute>
</VocabularyElement>
</VocabularyElementList>
</Vocabulary>
</VocabularyList>
</EPCISMasterData>
</extension>
<gslushc:dscsaTransactionStatement>
<gslushc:affirmTransactionStatement>true</gslushc:affirmTransactionStatement>
<gslushc:legalNotice>Seller has complied with each applicable subsection of FDCA Sec.
581 (27) (A) - (G).</gslushc:legalNotice>
</gslushc:dscsaTransactionStatement>
</EPCISHeader>
<EPCISBody>
<EventList>
<!-- Transaction Information (TI) -->
<ObjectEvent>
<eventTime>2014-04-01T10:11:12Z</eventTime>
<eventTimeZoneOffset>-05:00</eventTimeZoneOffset>
<epcList/>
<action>OBSERVE</action>
<bizStep>urn:epcglobal:cbv:bizstep:shipping</bizStep>
<disposition>urn:epcglobal:cbv:disp:in_transit</disposition>
<readPoint>
<id>urn:epc:id:sgln:030000.000000.0</id>
</readPoint>
<extension>
<quantityList>
<quantityElement>
<epcClass>urn:epc:class:lgtn:030000.0000001.L1</epcClass>
<quantity>100</quantity>
</quantityElement>
</quantityList>
<sourceList>
<source
type="urn:epcglobal:cbv:sdt:owning_party">urn:epc:id:sgln:030000.000000.0</source>
</sourceList>
<destinationList>
<destination
type="urn:epcglobal:cbv:sdt:owning_party">urn:epc:id:sgln:0353579.00001.0</destination>
</destinationList>

```

```

        </extension>
      </ObjectEvent>
    </EventList>
  </EPCISBody>
</epcis:EPCISDocument>

```

13.2 Sample XML: R → W1

Reference File: https://resources.gs1us.org/Portals/0/xml/LotChoreo-RePackaging_Example1-RtoW1.xml

```

<?xml version="1.0" encoding="UTF-8" standalone="yes"?>
<!-- Lot Choreography End to End Examples: REPACKAGING - EXAMPLE 1: R->W1 -->
<epcis:EPCISDocument xmlns:cbvmda="urn:epcglobal:cbv:mda"
xmlns:sbdh="http://www.unece.org/cefact/namespaces/StandardBusinessDocumentHeader"
xmlns:gslushc="http://epcis.gs1us.org/hc/ns" xmlns:epcis="urn:epcglobal:epcis:xsd:1"
schemaVersion="1.2" xsi:schemaLocation="urn:epcglobal:epcis:xsd:1 EPCglobal-epcis-1_2.xsd"
xmlns:xsi="http://www.w3.org/2001/XMLSchema-instance" creationDate="2014-06-01T15:14:27.574-
04:00">
  <EPCISHeader>
    <sbdh:StandardBusinessDocumentHeader>
      <sbdh:HeaderVersion>1.0</sbdh:HeaderVersion>
      <sbdh:Sender>
        <sbdh:Identifier
Authority="SGLN">urn:epc:id:sgln:0353579.00001.0</sbdh:Identifier>
        </sbdh:Sender>
      <sbdh:Receiver>
        <sbdh:Identifier
Authority="SGLN">urn:epc:id:sgln:0614141.00000.0</sbdh:Identifier>
        </sbdh:Receiver>
      <sbdh:DocumentIdentification>
        <sbdh:Standard>EPCglobal</sbdh:Standard>
        <sbdh:TypeVersion>1.0</sbdh:TypeVersion>
        <sbdh:InstanceIdentifier>1234567890</sbdh:InstanceIdentifier>
        <sbdh:Type>Events</sbdh:Type>
        <sbdh:CreationDateAndTime>2014-06-01T15:14:27.574-04:00</sbdh:CreationDateAndTime>
      </sbdh:DocumentIdentification>
    </sbdh:StandardBusinessDocumentHeader>
    <extension>
      <EPCISMasterData>
        <VocabularyList>
          <Vocabulary type="urn:epcglobal:epcis:vtype:EPCClass">
            <VocabularyElementList>
              <VocabularyElement id="urn:epc:class:lgtn:0353579.012610.L123">
                <attribute id="urn:epcglobal:cbv:mda#itemExpirationDate">2015-10-
31</attribute>
              </VocabularyElement>
              <VocabularyElement id="urn:epc:idpat:sgtin:0353579.012610.*">
                <attribute
id="urn:epcglobal:cbv:mda#additionalTradeItemIdentification">53579012610</attribute>
                <attribute
id="urn:epcglobal:cbv:mda#additionalTradeItemIdentificationTypeCode">FDA_NDC_11</attribute>
                <attribute
id="urn:epcglobal:cbv:mda#regulatedProductName">REpcistra</attribute>
                <attribute
id="urn:epcglobal:cbv:mda#manufacturerOfTradeItemPartyName">GS1 Repackager LLC</attribute>
                <attribute id="urn:epcglobal:cbv:mda#dosageFormType">PILL</attribute>
                <attribute
id="urn:epcglobal:cbv:mda#strengthDescription">100mg</attribute>
              </VocabularyElementList>
            </Vocabulary>
          </VocabularyList>
        </EPCISMasterData>
      </extension>
    </EPCISHeader>
  </EPCISDocument>

```



```

        <sourceList>
          <source
type="urn:epcglobal:cbv:sdt:owning_party">urn:epc:id:sgln:0353579.00001.0</source>
        </sourceList>
        <destinationList>
          <destination
type="urn:epcglobal:cbv:sdt:owning_party">urn:epc:id:sgln:0614141.00000.0</destination>
        </destinationList>
      </extension>
    </ObjectEvent>
  </EventList>
</EPCISBody>
</epcis:EPCISDocument>

```

13.3 Sample XML: W1 → D

Reference File: <https://resources.gs1us.org/Portals/0/xml/LotChoreo-RePackaging Example1-WitoD.xml>

```

<?xml version="1.0" encoding="UTF-8" standalone="yes"?>
<!-- Lot Choreography End to End Examples: REPACKAGING - EXAMPLE 1: W1->D -->
<epcis:EPCISDocument xmlns:cbvmda="urn:epcglobal:cbv:mda"
xmlns:sbdh="http://www.unece.org/cefact/namespaces/StandardBusinessDocumentHeader"
xmlns:gslushc="http://epcis.gs1us.org/hc/ns" xmlns:epcis="urn:epcglobal:epcis:xsd:1"
schemaVersion="1.2" xsi:schemaLocation="urn:epcglobal:epcis:xsd:1 EPCglobal-epcis-1_2.xsd"
xmlns:xsi="http://www.w3.org/2001/XMLSchema-instance" creationDate="2014-06-02T15:14:27.574-
04:00">
  <EPCISHeader>
    <sbdh:StandardBusinessDocumentHeader>
      <sbdh:HeaderVersion>1.0</sbdh:HeaderVersion>
      <sbdh:Sender>
        <sbdh:Identifier
Authority="SGLN">urn:epc:id:sgln:0614141.00000.0</sbdh:Identifier>
      </sbdh:Sender>
      <sbdh:Receiver>
        <sbdh:Identifier
Authority="SGLN">urn:epc:id:sgln:5012345.00000.0</sbdh:Identifier>
      </sbdh:Receiver>
      <sbdh:DocumentIdentification>
        <sbdh:Standard>EPCglobal</sbdh:Standard>
        <sbdh:TypeVersion>1.0</sbdh:TypeVersion>
        <sbdh:InstanceIdentifier>1234567890</sbdh:InstanceIdentifier>
        <sbdh:Type>Events</sbdh:Type>
        <sbdh:CreationDateAndTime>2014-06-02T15:14:27.574-04:00</sbdh:CreationDateAndTime>
      </sbdh:DocumentIdentification>
    </sbdh:StandardBusinessDocumentHeader>
    <extension>
      <EPCISMasterData>
        <VocabularyList>
          <Vocabulary type="urn:epcglobal:epcis:vtype:EPCClass">
            <VocabularyElementList>
              <VocabularyElement id="urn:epc:idpat:sgtin:0353579.012610.*">
                <attribute
id="urn:epcglobal:cbv:mda#additionalTradeItemIdentification">53579012610</attribute>
                <attribute
id="urn:epcglobal:cbv:mda#additionalTradeItemIdentificationTypeCode">FDA_NDC_11</attribute>
                <attribute
id="urn:epcglobal:cbv:mda#regulatedProductName">REpcistra</attribute>
                <attribute
id="urn:epcglobal:cbv:mda#manufacturerOfTradeItemPartyName">GS1 Repackager LLC</attribute>
              </VocabularyElement>
            </VocabularyElementList>
          </Vocabulary>
        </VocabularyList>
      </EPCISMasterData>
    </extension>
  </EPCISHeader>

```

```

                <attribute id="urn:epcglobal:cbv:mda#dosageFormType">PILL</attribute>
                <attribute
id="urn:epcglobal:cbv:mda#strengthDescription">100mg</attribute>
                <attribute id="urn:epcglobal:cbv:mda#netContentDescription">250
pills</attribute>
            </VocabularyElement>
        </VocabularyElementList>
    </Vocabulary>
    <Vocabulary type="urn:epcglobal:epcis:vtype:Location">
        <VocabularyElementList>
            <VocabularyElement id="urn:epc:id:sgln:0353579.00001.0">
                <attribute id="urn:epcglobal:cbv:mda#name">GS1 Repackager
LLC</attribute>
                <attribute id="urn:epcglobal:cbv:mda#streetAddressOne">201 Broadway
Ave</attribute>
                <attribute id="urn:epcglobal:cbv:mda#streetAddressTwo">Bldg
10</attribute>
                <attribute id="urn:epcglobal:cbv:mda#city">Cambridge</attribute>
                <attribute id="urn:epcglobal:cbv:mda#state">MA</attribute>
                <attribute id="urn:epcglobal:cbv:mda#postalCode">02138</attribute>
                <attribute id="urn:epcglobal:cbv:mda#countryCode">US</attribute>
            </VocabularyElement>
            <VocabularyElement id="urn:epc:id:sgln:0614141.00000.0">
                <attribute id="urn:epcglobal:cbv:mda#name">GS1 Drug Distro
LLC</attribute>
                <attribute id="urn:epcglobal:cbv:mda#streetAddressOne">230 Park Ave
S</attribute>
                <attribute id="urn:epcglobal:cbv:mda#city">New York</attribute>
                <attribute id="urn:epcglobal:cbv:mda#state">NY</attribute>
                <attribute id="urn:epcglobal:cbv:mda#postalCode">10003-
1502</attribute>
                <attribute id="urn:epcglobal:cbv:mda#countryCode">US</attribute>
            </VocabularyElement>
            <VocabularyElement id="urn:epc:id:sgln:5012345.00000.0">
                <attribute id="urn:epcglobal:cbv:mda#name">GS1 Pere et Fils
Pharmacy</attribute>
                <attribute id="urn:epcglobal:cbv:mda#streetAddressOne">1313
Mockingbird Lane</attribute>
                <attribute id="urn:epcglobal:cbv:mda#city">Paris</attribute>
                <attribute id="urn:epcglobal:cbv:mda#state">TX</attribute>
                <attribute id="urn:epcglobal:cbv:mda#postalCode">76543</attribute>
                <attribute id="urn:epcglobal:cbv:mda#countryCode">US</attribute>
            </VocabularyElement>
        </VocabularyElementList>
    </Vocabulary>
</VocabularyList>
</EPCISMasterData>
</extension>
<gslushc:dscsaTransactionStatement>
    <gslushc:affirmTransactionStatement>true</gslushc:affirmTransactionStatement>
    <gslushc:legalNotice>Seller has complied with each applicable subsection of FDCA Sec.
581(27)(A)-(G). As indicated below, product was purchased directly from the manufacturer,
manufacturer's exclusive distributor or repackager who purchased directly from a
manufacturer.</gslushc:legalNotice>
</gslushc:dscsaTransactionStatement>
</EPCISHeader>
<EPCISBody>
    <EventList>
        <!-- Transaction History (TH) -->
        <ObjectEvent>
            <eventTime>1970-01-01T00:00:00.000Z</eventTime>

```

```

<eventTimeZoneOffset>+00:00</eventTimeZoneOffset>
<epcList/>
<action>OBSERVE</action>
<bizStep>urn:epcglobal:cbv:bizstep:shipping</bizStep>
<disposition>urn:epcglobal:cbv:disp:in_transit</disposition>
<readPoint>
  <id>urn:epc:id:sgln:0353579.00001.0</id>
</readPoint>
<extension>
  <quantityList>
    <quantityElement>
      <epcClass>urn:epc:idpat:sgtin:0353579.012610.*</epcClass>
      <quantity>50</quantity>
    </quantityElement>
  </quantityList>
  <sourceList>
    <source
type="urn:epcglobal:cbv:sdt:owning_party">urn:epc:id:sgln:0353579.00001.0</source>
    </sourceList>
    <destinationList>
      <destination
type="urn:epcglobal:cbv:sdt:owning_party">urn:epc:id:sgln:0614141.00000.0</destination>
    </destinationList>
  </extension>
</ObjectEvent>
<!-- Transaction Information (TI) -->
<ObjectEvent>
  <eventTime>2014-06-02T11:00:00.000-04:00</eventTime>
  <eventTimeZoneOffset>-04:00</eventTimeZoneOffset>
  <epcList/>
  <action>OBSERVE</action>
  <bizStep>urn:epcglobal:cbv:bizstep:shipping</bizStep>
  <disposition>urn:epcglobal:cbv:disp:in_transit</disposition>
  <readPoint>
    <id>urn:epc:id:sgln:0614141.00000.0</id>
  </readPoint>
  <extension>
    <quantityList>
      <quantityElement>
        <epcClass>urn:epc:idpat:sgtin:0353579.012610.*</epcClass>
        <quantity>50</quantity>
      </quantityElement>
    </quantityList>
    <sourceList>
      <source
type="urn:epcglobal:cbv:sdt:owning_party">urn:epc:id:sgln:0614141.00000.0</source>
      </sourceList>
      <destinationList>
        <destination
type="urn:epcglobal:cbv:sdt:owning_party">urn:epc:id:sgln:5012345.00000.0</destination>
      </destinationList>
    </extension>
    <gslushc:directPurchase value="true"/>
  </ObjectEvent>
</EventList>
</EPCISBody>
</epcis:EPCISDocument>

```

14 Repackaging Scenario – Example 2

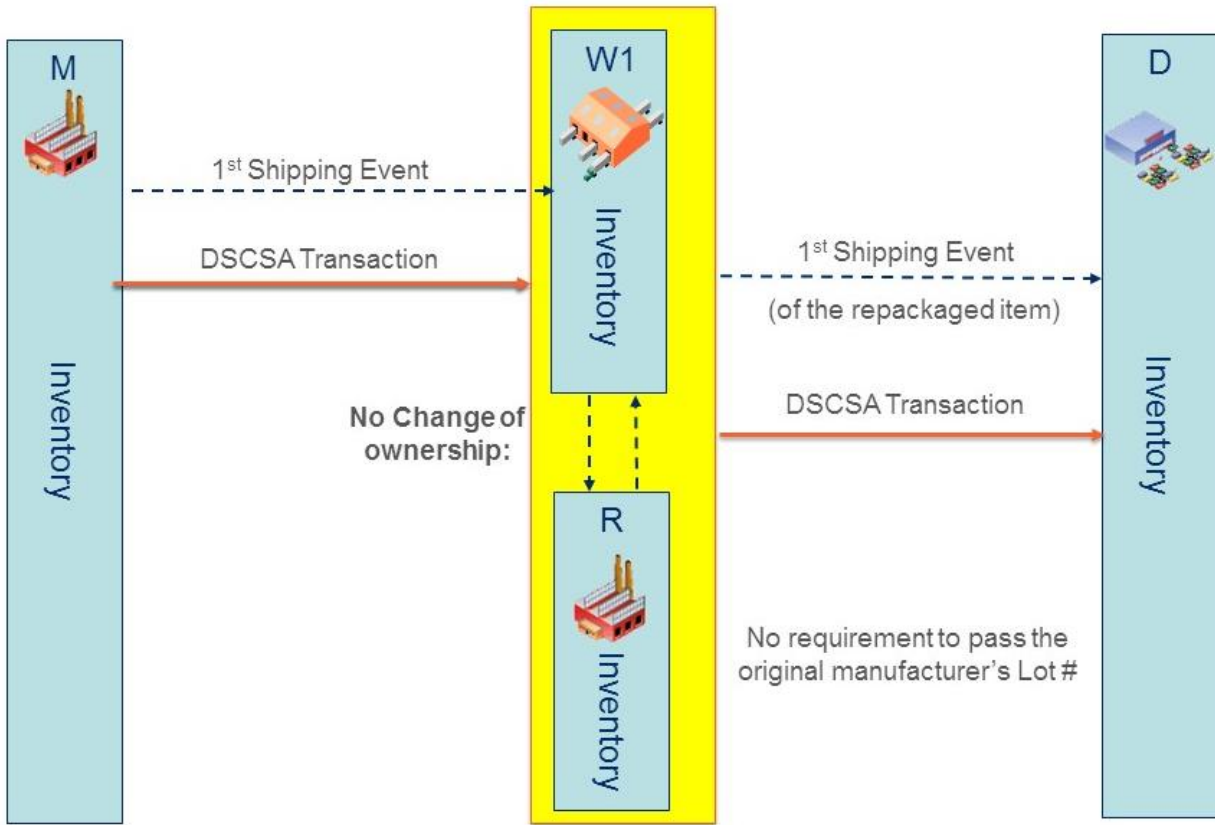

14.1 Sample XML: M → W1



Note: Because the manufacturer is the DSCSA transaction owner, the DSCSA transaction begins with the manufacturer. Therefore, the message content of the M → W1 transaction in this example is identical to the content of the M → W1 transaction in the [Direct Purchase Example 1](#).

Reference File: <https://resources.gs1us.org/Portals/0/xml/LotChoreo-RePackaging Example2-MtoW1.xml>

```
<?xml version="1.0" encoding="UTF-8" standalone="yes"?>
<!-- Lot Choreography End to End Examples: REPACKAGING - EXAMPLE 2: M->W1 -->
<!-- The M->W1 transaction in this example is identical to the M->W1 content for Direct
Purchase Example1 -->
<epcis:EPCISDocument xmlns:cbvmda="urn:epcglobal:cbv:mda"
xmlns:sbdh="http://www.unece.org/cefact/namespaces/StandardBusinessDocumentHeader"
xmlns:gs1ushc="http://epcis.gs1us.org/hc/ns" xmlns:epcis="urn:epcglobal:epcis:xsd:1"
schemaVersion="1.2" xsi:schemaLocation="urn:epcglobal:epcis:xsd:1 EPCglobal-epcis-1_2.xsd"
xmlns:xsi="http://www.w3.org/2001/XMLSchema-instance" creationDate="2014-05-30T15:14:27.574-
04:00">
  <EPCISHeader>
    <sbdh:StandardBusinessDocumentHeader>
      <sbdh:HeaderVersion>1.0</sbdh:HeaderVersion>
      <sbdh:Sender>
        <sbdh:Identifier
Authority="SGLN">urn:epc:id:sgln:030000.000000.0</sbdh:Identifier>
        </sbdh:Sender>
        <sbdh:Receiver>
          <sbdh:Identifier
Authority="SGLN">urn:epc:id:sgln:0614141.000000.0</sbdh:Identifier>
          </sbdh:Receiver>
          <sbdh:DocumentIdentification>
            <sbdh:Standard>EPCglobal</sbdh:Standard>
            <sbdh:TypeVersion>1.0</sbdh:TypeVersion>
            <sbdh:InstanceIdentifier>1234567890</sbdh:InstanceIdentifier>
            <sbdh:Type>Events</sbdh:Type>
            <sbdh:CreationDateAndTime>2014-05-30T15:14:27.574-04:00</sbdh:CreationDateAndTime>
          </sbdh:DocumentIdentification>
        </sbdh:StandardBusinessDocumentHeader>
        <extension>
          <EPCISMasterData>
            <VocabularyList>
              <Vocabulary type="urn:epcglobal:epcis:vtype:EPCClass">
                <VocabularyElementList>
                  <VocabularyElement id="urn:epc:class:lgtin:030000.0000001.L1">
                    <attribute id="urn:epcglobal:cbv:mda#itemExpirationDate">2015-10-
31</attribute>
                  </VocabularyElement>
                  <VocabularyElement id="urn:epc:idpat:sgtin:030000.0000001.*">
                    <attribute
id="urn:epcglobal:cbv:mda#additionalTradeItemIdentification">00000000001</attribute>
                    <attribute
id="urn:epcglobal:cbv:mda#additionalTradeItemIdentificationTypeCode">FDA_NDC_11</attribute>
                    <attribute
id="urn:epcglobal:cbv:mda#regulatedProductName">Epcistra</attribute>
                    <attribute
id="urn:epcglobal:cbv:mda#manufacturerOfTradeItemPartyName">GS1 Pharma LLC</attribute>
                    <attribute id="urn:epcglobal:cbv:mda#dosageFormType">PILL</attribute>
                    <attribute
id="urn:epcglobal:cbv:mda#strengthDescription">100mg</attribute>
```

```

                    <attribute id="urn:epcglobal:cbv:mda#netContentDescription">500
pills</attribute>
                </VocabularyElement>
            </VocabularyElementList>
        </Vocabulary>
        <Vocabulary type="urn:epcglobal:epcis:vtype:Location">
            <VocabularyElementList>
                <VocabularyElement id="urn:epc:id:sgln:030000.000000.0">
                    <attribute id="urn:epcglobal:cbv:mda#name">GS1 Pharma LLC</attribute>
                    <attribute id="urn:epcglobal:cbv:mda#streetAddressOne">1295 S George
Ave</attribute>
                    <attribute id="urn:epcglobal:cbv:mda#streetAddressTwo">Room
378</attribute>
                    <attribute id="urn:epcglobal:cbv:mda#city">Washington</attribute>
                    <attribute id="urn:epcglobal:cbv:mda#state">DC</attribute>
                    <attribute id="urn:epcglobal:cbv:mda#postalCode">12345-
6789</attribute>
                    <attribute id="urn:epcglobal:cbv:mda#countryCode">US</attribute>
                </VocabularyElement>
            <VocabularyElement id="urn:epc:id:sgln:0614141.000000.0">
                <attribute id="urn:epcglobal:cbv:mda#name">GS1 Drug Distro
LLC</attribute>
                <attribute id="urn:epcglobal:cbv:mda#streetAddressOne">230 Park Ave
S</attribute>
                <attribute id="urn:epcglobal:cbv:mda#city">New York</attribute>
                <attribute id="urn:epcglobal:cbv:mda#state">NY</attribute>
                <attribute id="urn:epcglobal:cbv:mda#postalCode">10003-
1502</attribute>
                <attribute id="urn:epcglobal:cbv:mda#countryCode">US</attribute>
            </VocabularyElement>
        </VocabularyElementList>
    </Vocabulary>
</VocabularyList>
</EPCISMasterData>
</extension>
<gslushc:dscsaTransactionStatement>
    <gslushc:affirmTransactionStatement>true</gslushc:affirmTransactionStatement>
    <gslushc:legalNotice>Seller has complied with each applicable subsection of FDCA Sec.
581 (27) (A) - (G).</gslushc:legalNotice>
</gslushc:dscsaTransactionStatement>
</EPCISHeader>
<EPCISBody>
    <EventList>
        <!-- Transaction Information (TI) -->
        <ObjectEvent>
            <eventTime>2014-04-01T10:11:12Z</eventTime>
            <eventTimeZoneOffset>-05:00</eventTimeZoneOffset>
            <epcList/>
            <action>OBSERVE</action>
            <bizStep>urn:epcglobal:cbv:bizstep:shipping</bizStep>
            <disposition>urn:epcglobal:cbv:disp:in_transit</disposition>
            <readPoint>
                <id>urn:epc:id:sgln:030000.000000.0</id>
            </readPoint>
            <extension>
                <quantityList>
                    <quantityElement>
                        <epcClass>urn:epc:class:lgtin:030000.0000001.L1</epcClass>
                        <quantity>100</quantity>
                    </quantityElement>
                </quantityList>
            </extension>
        </ObjectEvent>
    </EventList>

```

```

        <sourceList>
          <source
type="urn:epcglobal:cbv:sdt:owning_party">urn:epc:id:sgln:030000.000000.0</source>
        </sourceList>
        <destinationList>
          <destination
type="urn:epcglobal:cbv:sdt:owning_party">urn:epc:id:sgln:0614141.00000.0</destination>
        </destinationList>
      </extension>
    </ObjectEvent>
  </EventList>
</EPCISBody>
</epcis:EPCISDocument>

```

14.2 Sample XML: W1 → D



Note: Because W1 is the DSCSA owner, the DSCSA transaction for W1 → D in this example is similar to the W1 → D in the [Direct Purchase Example 1](#) except the product has been re-packaged before shipping to D.

Reference File: <https://resources.gs1us.org/Portals/0/xml/LotChoreo-RePackaging Example2-W1toD.xml>

```

<?xml version="1.0" encoding="UTF-8" standalone="yes"?>
<!-- Lot Choreography End to End Examples: REPACKAGING - EXAMPLE 2: W1->D -->
<!-- Since W1 re-packaged the product using the re-packager services, W1 is now the originator
of the DSCSA transaction
for the re-packaged products. Therefore, only TI is needed to be passed by W1 to D and there's
no direct purchase flag. -->
<epcis:EPCISDocument xmlns:cbvmda="urn:epcglobal:cbv:mda"
xmlns:sbdh="http://www.unece.org/cefact/namespaces/StandardBusinessDocumentHeader"
xmlns:gslushc="http://epcis.gslus.org/hc/ns" xmlns:epcis="urn:epcglobal:epcis:xsd:1"
schemaVersion="1.2" xsi:schemaLocation="urn:epcglobal:epcis:xsd:1 EPCglobal-epcis-1_2.xsd"
xmlns:xsi="http://www.w3.org/2001/XMLSchema-instance" creationDate="2014-05-30T15:14:27.574-
04:00">
  <EPCISHeader>
    <sbdh:StandardBusinessDocumentHeader>
      <sbdh:HeaderVersion>1.0</sbdh:HeaderVersion>
      <sbdh:Sender>
        <sbdh:Identifier
Authority="SGLN">urn:epc:id:sgln:0614141.00000.0</sbdh:Identifier>
      </sbdh:Sender>
      <sbdh:Receiver>
        <sbdh:Identifier
Authority="SGLN">urn:epc:id:sgln:5012345.00000.0</sbdh:Identifier>
      </sbdh:Receiver>
      <sbdh:DocumentIdentification>
        <sbdh:Standard>EPCglobal</sbdh:Standard>
        <sbdh:TypeVersion>1.0</sbdh:TypeVersion>
        <sbdh:InstanceIdentifier>1234567890</sbdh:InstanceIdentifier>
        <sbdh:Type>Events</sbdh:Type>
        <sbdh:CreationDateAndTime>2014-05-30T15:14:27.574-04:00</sbdh:CreationDateAndTime>
      </sbdh:DocumentIdentification>
    </sbdh:StandardBusinessDocumentHeader>
    <extension>
      <EPCISMasterData>
        <VocabularyList>
          <Vocabulary type="urn:epcglobal:epcis:vtype:EPCClass">

```

```

    <VocabularyElementList>
      <VocabularyElement id="urn:epc:class:lgtn:0353579.012610.L123">
        <attribute id="urn:epcglobal:cbv:mda#itemExpirationDate">2015-10-
31</attribute>
      </VocabularyElement>
      <VocabularyElement id="urn:epc:idpat:sgtin:0353579.012610.*">
        <attribute
id="urn:epcglobal:cbv:mda#additionalTradeItemIdentification">53579012610</attribute>
        <attribute
id="urn:epcglobal:cbv:mda#additionalTradeItemIdentificationTypeCode">FDA_NDC_11</attribute>
        <attribute
id="urn:epcglobal:cbv:mda#regulatedProductName">REpcistra</attribute>
        <attribute
id="urn:epcglobal:cbv:mda#manufacturerOfTradeItemPartyName">GS1 Repackager LLC</attribute>
        <attribute id="urn:epcglobal:cbv:mda#dosageFormType">PILL</attribute>
        <attribute
id="urn:epcglobal:cbv:mda#strengthDescription">100mg</attribute>
        <attribute id="urn:epcglobal:cbv:mda#netContentDescription">250
pills</attribute>
      </VocabularyElement>
    </VocabularyElementList>
  </Vocabulary>
  <Vocabulary type="urn:epcglobal:epcis:vtype:Location">
    <VocabularyElementList>
      <VocabularyElement id="urn:epc:id:sgln:0614141.00000.0">
        <attribute id="urn:epcglobal:cbv:mda#name">GS1 Drug Distro
LLC</attribute>
        <attribute id="urn:epcglobal:cbv:mda#streetAddressOne">230 Park Ave
S</attribute>
        <attribute id="urn:epcglobal:cbv:mda#city">New York</attribute>
        <attribute id="urn:epcglobal:cbv:mda#state">NY</attribute>
        <attribute id="urn:epcglobal:cbv:mda#postalCode">10003-
1502</attribute>
        <attribute id="urn:epcglobal:cbv:mda#countryCode">US</attribute>
      </VocabularyElement>
      <VocabularyElement id="urn:epc:id:sgln:5012345.00000.0">
        <attribute id="urn:epcglobal:cbv:mda#name">GS1 Pere et Fils
Pharmacy</attribute>
        <attribute id="urn:epcglobal:cbv:mda#streetAddressOne">1313
Mockingbird Lane</attribute>
        <attribute id="urn:epcglobal:cbv:mda#city">Paris</attribute>
        <attribute id="urn:epcglobal:cbv:mda#state">TX</attribute>
        <attribute id="urn:epcglobal:cbv:mda#postalCode">76543</attribute>
        <attribute id="urn:epcglobal:cbv:mda#countryCode">US</attribute>
      </VocabularyElement>
    </VocabularyElementList>
  </Vocabulary>
</VocabularyList>
</EPCISMasterData>
</extension>
<gslushc:dscsaTransactionStatement>
  <gslushc:affirmTransactionStatement>true</gslushc:affirmTransactionStatement>
  <gslushc:legalNotice>Seller has complied with each applicable subsection of FDCA Sec.
581 (27) (A) - (G).</gslushc:legalNotice>
</gslushc:dscsaTransactionStatement>
</EPCISHeader>
<EPCISBody>
  <EventList>
    <!-- Transaction Information (TI) -->
    <ObjectEvent>
      <eventTime>2014-04-05T11:00:00.000-04:00</eventTime>

```

```
<eventTimeZoneOffset>-04:00</eventTimeZoneOffset>
<epcList/>
<action>OBSERVE</action>
<bizStep>urn:epcglobal:cbv:bizstep:shipping</bizStep>
<disposition>urn:epcglobal:cbv:disp:in_transit</disposition>
<readPoint>
  <id>urn:epc:id:sgln:0614141.00000.0</id>
</readPoint>
<extension>
  <quantityList>
    <quantityElement>
      <epcClass>urn:epc:class:lgtin:0353579.012610.L123</epcClass>
      <quantity>200</quantity>
    </quantityElement>
  </quantityList>
  <sourceList>
    <source
type="urn:epcglobal:cbv:sdt:owning_party">urn:epc:id:sgln:0614141.00000.0</source>
    </sourceList>
    <destinationList>
      <destination
type="urn:epcglobal:cbv:sdt:owning_party">urn:epc:id:sgln:5012345.00000.0</destination>
    </destinationList>
  </extension>
</ObjectEvent>
</EventList>
</EPCISBody>
</epcis:EPCISDocument>
```

15 Repackaging Scenario – Example 3

(ASSUMPTION: RE-PACKAGER (R/W1') IS A SUBSIDIARY OF W1)

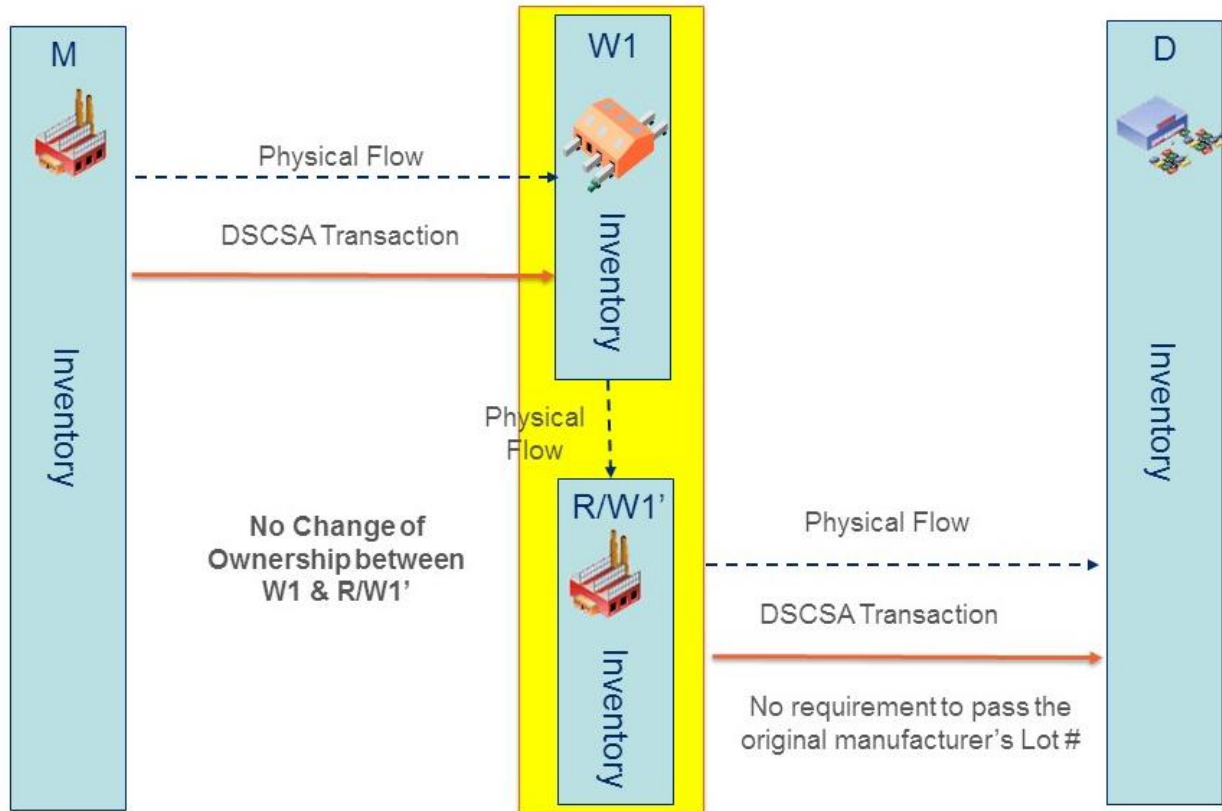

15.1 Sample XML: M → W1



Note: Because the manufacturer is the DSCSA transaction owner, the DSCSA transaction begins with the manufacturer. Therefore, the message content of the M → W1 transaction in this example is identical to the content of the M → W1 transaction in the [Direct Purchase Example 1](#).

Reference File: <https://resources.gs1us.org/Portals/0/xml/LotChoreo-RePackaging Example3-MtoW1.xml>

```
<?xml version="1.0" encoding="UTF-8" standalone="yes"?>
<!-- Lot Choreography End to End Examples: REPACKAGING - EXAMPLE 3: M->W1 -->
<!-- The M->W1 transaction in this example is identical to the M->W1 content for Direct
Purchase Example1 -->
<epcis:EPCISDocument xmlns:cbvmda="urn:epcglobal:cbv:mda"
xmlns:sbdh="http://www.unece.org/cefact/namespaces/StandardBusinessDocumentHeader"
xmlns:gs1ushc="http://epcis.gs1us.org/hc/ns" xmlns:epcis="urn:epcglobal:epcis:xsd:1"
schemaVersion="1.2" xsi:schemaLocation="urn:epcglobal:epcis:xsd:1 EPCglobal-epcis-1_2.xsd"
xmlns:xsi="http://www.w3.org/2001/XMLSchema-instance" creationDate="2014-05-30T15:14:27.574-
04:00">
  <EPCISHeader>
    <sbdh:StandardBusinessDocumentHeader>
      <sbdh:HeaderVersion>1.0</sbdh:HeaderVersion>
      <sbdh:Sender>
        <sbdh:Identifier
Authority="SGLN">urn:epc:id:sgln:030000.000000.0</sbdh:Identifier>
        </sbdh:Sender>
        <sbdh:Receiver>
          <sbdh:Identifier
Authority="SGLN">urn:epc:id:sgln:0614141.000000.0</sbdh:Identifier>
          </sbdh:Receiver>
        <sbdh:DocumentIdentification>
          <sbdh:Standard>EPCglobal</sbdh:Standard>
          <sbdh:TypeVersion>1.0</sbdh:TypeVersion>
          <sbdh:InstanceIdentifier>1234567890</sbdh:InstanceIdentifier>
          <sbdh:Type>Events</sbdh:Type>
          <sbdh:CreationDateAndTime>2014-05-30T15:14:27.574-04:00</sbdh:CreationDateAndTime>
        </sbdh:DocumentIdentification>
      </sbdh:StandardBusinessDocumentHeader>
      <extension>
        <EPCISMasterData>
          <VocabularyList>
            <Vocabulary type="urn:epcglobal:epcis:vtype:EPCClass">
              <VocabularyElementList>
                <VocabularyElement id="urn:epc:class:lgtin:030000.0000001.L1">
                  <attribute id="urn:epcglobal:cbv:mda#itemExpirationDate">2015-10-
31</attribute>
                </VocabularyElement>
                <VocabularyElement id="urn:epc:idpat:sgtin:030000.0000001.*">
                  <attribute
id="urn:epcglobal:cbv:mda#additionalTradeItemIdentification">00000000001</attribute>
                  <attribute
id="urn:epcglobal:cbv:mda#additionalTradeItemIdentificationTypeCode">FDA_NDC_11</attribute>
                  <attribute
id="urn:epcglobal:cbv:mda#regulatedProductName">Epcistra</attribute>
                  <attribute
id="urn:epcglobal:cbv:mda#manufacturerOfTradeItemPartyName">GS1 Pharma LLC</attribute>
                  <attribute id="urn:epcglobal:cbv:mda#dosageFormType">PILL</attribute>
                  <attribute
id="urn:epcglobal:cbv:mda#strengthDescription">100mg</attribute>
```

```

                    <attribute id="urn:epcglobal:cbv:mda#netContentDescription">500
pills</attribute>
                </VocabularyElement>
            </VocabularyElementList>
        </Vocabulary>
        <Vocabulary type="urn:epcglobal:epcis:vtype:Location">
            <VocabularyElementList>
                <VocabularyElement id="urn:epc:id:sgln:030000.000000.0">
                    <attribute id="urn:epcglobal:cbv:mda#name">GS1 Pharma LLC</attribute>
                    <attribute id="urn:epcglobal:cbv:mda#streetAddressOne">1295 S George
Ave</attribute>
                    <attribute id="urn:epcglobal:cbv:mda#streetAddressTwo">Room
378</attribute>
                    <attribute id="urn:epcglobal:cbv:mda#city">Washington</attribute>
                    <attribute id="urn:epcglobal:cbv:mda#state">DC</attribute>
                    <attribute id="urn:epcglobal:cbv:mda#postalCode">12345-
6789</attribute>
                    <attribute id="urn:epcglobal:cbv:mda#countryCode">US</attribute>
                </VocabularyElement>
            <VocabularyElement id="urn:epc:id:sgln:0614141.00000.0">
                <attribute id="urn:epcglobal:cbv:mda#name">GS1 Drug Distro
LLC</attribute>
                <attribute id="urn:epcglobal:cbv:mda#streetAddressOne">230 Park Ave
S</attribute>
                <attribute id="urn:epcglobal:cbv:mda#city">New York</attribute>
                <attribute id="urn:epcglobal:cbv:mda#state">NY</attribute>
                <attribute id="urn:epcglobal:cbv:mda#postalCode">10003-
1502</attribute>
                <attribute id="urn:epcglobal:cbv:mda#countryCode">US</attribute>
            </VocabularyElement>
        </VocabularyElementList>
    </Vocabulary>
</VocabularyList>
</EPCISMasterData>
</extension>
<gslushc:dscsaTransactionStatement>
    <gslushc:affirmTransactionStatement>true</gslushc:affirmTransactionStatement>
    <gslushc:legalNotice>Seller has complied with each applicable subsection of FDCA Sec.
581 (27) (A) - (G).</gslushc:legalNotice>
</gslushc:dscsaTransactionStatement>
</EPCISHeader>
<EPCISBody>
    <EventList>
        <!-- Transaction Information (TI) -->
        <ObjectEvent>
            <eventTime>2014-04-01T10:11:12Z</eventTime>
            <eventTimeZoneOffset>-05:00</eventTimeZoneOffset>
            <epcList/>
            <action>OBSERVE</action>
            <bizStep>urn:epcglobal:cbv:bizstep:shipping</bizStep>
            <disposition>urn:epcglobal:cbv:disp:in_transit</disposition>
            <readPoint>
                <id>urn:epc:id:sgln:030000.000000.0</id>
            </readPoint>
            <extension>
                <quantityList>
                    <quantityElement>
                        <epcClass>urn:epc:class:lgtin:030000.0000001.L1</epcClass>
                        <quantity>100</quantity>
                    </quantityElement>
                </quantityList>
            </extension>
        </ObjectEvent>
    </EventList>

```



```

    <sourceList>
      <source
type="urn:epcglobal:cbv:sdt:owning_party">urn:epc:id:sgln:030000.000000.0</source>
    </sourceList>
    <destinationList>
      <destination
type="urn:epcglobal:cbv:sdt:owning_party">urn:epc:id:sgln:0614141.00000.0</destination>
    </destinationList>
  </extension>
</ObjectEvent>
</EventList>
</EPCISBody>
</epcis:EPCISDocument>

```

15.2 Sample XML: W1 → D



Note: Because W1 is the DSCSA owner, the DSCSA transaction for W1 → D in this example is similar to the DSCSA transaction for W1 → D in the [Direct Purchase Example 1](#). However, before shipping to D, the product has been re-packaged by R, who is also functioning as a subsidiary wholesaler W1' for W1. The repackaged products are owned by W1 and shipped to D from the distribution warehouse of W1'.

Reference File: <https://resources.gs1us.org/Portals/0/xml/LotChoreo-RePackaging Example3-W1toD.xml>

```

<?xml version="1.0" encoding="UTF-8" standalone="yes"?>
<!-- Lot Choreography End to End Examples: REPACKAGING - EXAMPLE 3: W1->D -->
<epcis:EPCISDocument xmlns:cbvmda="urn:epcglobal:cbv:mda"
xmlns:sbdh="http://www.unece.org/cefact/namespaces/StandardBusinessDocumentHeader"
xmlns:gslushc="http://epcis.gs1us.org/hc/ns" xmlns:epcis="urn:epcglobal:epcis:xsd:1"
schemaVersion="1.2" xsi:schemaLocation="urn:epcglobal:epcis:xsd:1 EPCglobal-epcis-1_2.xsd"
xmlns:xsi="http://www.w3.org/2001/XMLSchema-instance" creationDate="2014-05-30T15:14:27.574-
04:00">
  <EPCISHeader>
    <sbdh:StandardBusinessDocumentHeader>
      <sbdh:HeaderVersion>1.0</sbdh:HeaderVersion>
      <sbdh:Sender>
        <sbdh:Identifier
Authority="SGLN">urn:epc:id:sgln:0614141.00000.0</sbdh:Identifier>
      </sbdh:Sender>
      <sbdh:Receiver>
        <sbdh:Identifier
Authority="SGLN">urn:epc:id:sgln:5012345.00000.0</sbdh:Identifier>
      </sbdh:Receiver>
      <sbdh:DocumentIdentification>
        <sbdh:Standard>EPCglobal</sbdh:Standard>
        <sbdh:TypeVersion>1.0</sbdh:TypeVersion>
        <sbdh:InstanceIdentifier>1234567890</sbdh:InstanceIdentifier>
        <sbdh:Type>Events</sbdh:Type>
        <sbdh:CreationDateAndTime>2014-05-30T15:14:27.574-04:00</sbdh:CreationDateAndTime>
      </sbdh:DocumentIdentification>
    </sbdh:StandardBusinessDocumentHeader>
    <extension>
      <EPCISMasterData>
        <VocabularyList>
          <Vocabulary type="urn:epcglobal:epcis:vtype:EPCClass">
            <VocabularyElementList>
              <VocabularyElement id="urn:epc:class:lgtin:0353579.012610.L123">

```

```

        <attribute id="urn:epcglobal:cbv:mda#itemExpirationDate">2015-10-
31</attribute>
        </VocabularyElement>
        <VocabularyElement id="urn:epc:idpat:sgtin:0353579.012610.*">
        <attribute
id="urn:epcglobal:cbv:mda#additionalTradeItemIdentification">53579012610</attribute>
        <attribute
id="urn:epcglobal:cbv:mda#additionalTradeItemIdentificationTypeCode">FDA_NDC_11</attribute>
        <attribute
id="urn:epcglobal:cbv:mda#regulatedProductName">REpcistra</attribute>
        <attribute
id="urn:epcglobal:cbv:mda#manufacturerOfTradeItemPartyName">GS1 Repackager LLC</attribute>
        <attribute id="urn:epcglobal:cbv:mda#dosageFormType">PILL</attribute>
        <attribute
id="urn:epcglobal:cbv:mda#strengthDescription">100mg</attribute>
        <attribute id="urn:epcglobal:cbv:mda#netContentDescription">250
pills</attribute>
        </VocabularyElement>
        </VocabularyElementList>
    </Vocabulary>
    <Vocabulary type="urn:epcglobal:epcis:vtype:Location">
        <VocabularyElementList>
            <VocabularyElement id="urn:epc:id:sgln:0353579.00001.0">
                <attribute id="urn:epcglobal:cbv:mda#name">GS1 Repackager
LLC</attribute>
                <attribute id="urn:epcglobal:cbv:mda#streetAddressOne">201 Broadway
Ave</attribute>
                <attribute id="urn:epcglobal:cbv:mda#streetAddressTwo">Bldg
10</attribute>
                <attribute id="urn:epcglobal:cbv:mda#city">Cambridge</attribute>
                <attribute id="urn:epcglobal:cbv:mda#state">MA</attribute>
                <attribute id="urn:epcglobal:cbv:mda#postalCode">02138</attribute>
                <attribute id="urn:epcglobal:cbv:mda#countryCode">US</attribute>
            </VocabularyElement>
            <VocabularyElement id="urn:epc:id:sgln:0614141.00000.0">
                <attribute id="urn:epcglobal:cbv:mda#name">GS1 Drug Distro
LLC</attribute>
                <attribute id="urn:epcglobal:cbv:mda#streetAddressOne">230 Park Ave
S</attribute>
                <attribute id="urn:epcglobal:cbv:mda#city">New York</attribute>
                <attribute id="urn:epcglobal:cbv:mda#state">NY</attribute>
                <attribute id="urn:epcglobal:cbv:mda#postalCode">10003-
1502</attribute>
                <attribute id="urn:epcglobal:cbv:mda#countryCode">US</attribute>
            </VocabularyElement>
        </VocabularyElementList>
        <VocabularyElement id="urn:epc:id:sgln:5012345.00000.0">
            <attribute id="urn:epcglobal:cbv:mda#name">GS1 Pere et Fils
Pharmacy</attribute>
            <attribute id="urn:epcglobal:cbv:mda#streetAddressOne">1313
Mockingbird Lane</attribute>
            <attribute id="urn:epcglobal:cbv:mda#city">Paris</attribute>
            <attribute id="urn:epcglobal:cbv:mda#state">TX</attribute>
            <attribute id="urn:epcglobal:cbv:mda#postalCode">76543</attribute>
            <attribute id="urn:epcglobal:cbv:mda#countryCode">US</attribute>
        </VocabularyElement>
    </VocabularyElementList>
</Vocabulary>
</VocabularyList>
</EPCISMasterData>
</extension>
<gslushc:dscsaTransactionStatement>

```

```

        <gslushc:affirmTransactionStatement>true</gslushc:affirmTransactionStatement>
        <gslushc:legalNotice>Seller has complied with each applicable subsection of FDCA Sec.
581 (27) (A) - (G).</gslushc:legalNotice>
    </gslushc:dscsaTransactionStatement>
</EPCISHeader>
<EPCISBody>
    <EventList>
        <!-- Transaction Information (TI) -->
        <ObjectEvent>
            <eventTime>2014-04-05T11:00:00.000-04:00</eventTime>
            <eventTimeZoneOffset>-04:00</eventTimeZoneOffset>
            <epcList/>
            <action>OBSERVE</action>
            <bizStep>urn:epcglobal:cbv:bizstep:shipping</bizStep>
            <disposition>urn:epcglobal:cbv:disp:in_transit</disposition>
            <!--since R/W1' is the one shipping the re-packaged product to D, changed the sGLN
toR/W1' instead of W1 -->
            <readPoint>
                <id>urn:epc:id:sgln:0353579.00001.0</id>
            </readPoint>
            <extension>
                <quantityList>
                    <quantityElement>
                        <epcClass>urn:epc:class:lgtin:0353579.012610.L123</epcClass>
                        <quantity>200</quantity>
                    </quantityElement>
                </quantityList>
                <sourceList>
                    <source
type="urn:epcglobal:cbv:sdt:owning_party">urn:epc:id:sgln:0614141.00000.0</source>
                </sourceList>
                <destinationList>
                    <destination
type="urn:epcglobal:cbv:sdt:owning_party">urn:epc:id:sgln:5012345.00000.0</destination>
                </destinationList>
            </extension>
        </ObjectEvent>
    </EventList>
</EPCISBody>
</epcis:EPCISDocument>

```

16 Repackaging Scenario – Example 4

Scenario Assumption: re-packager is a third party, separately owned entity than W1

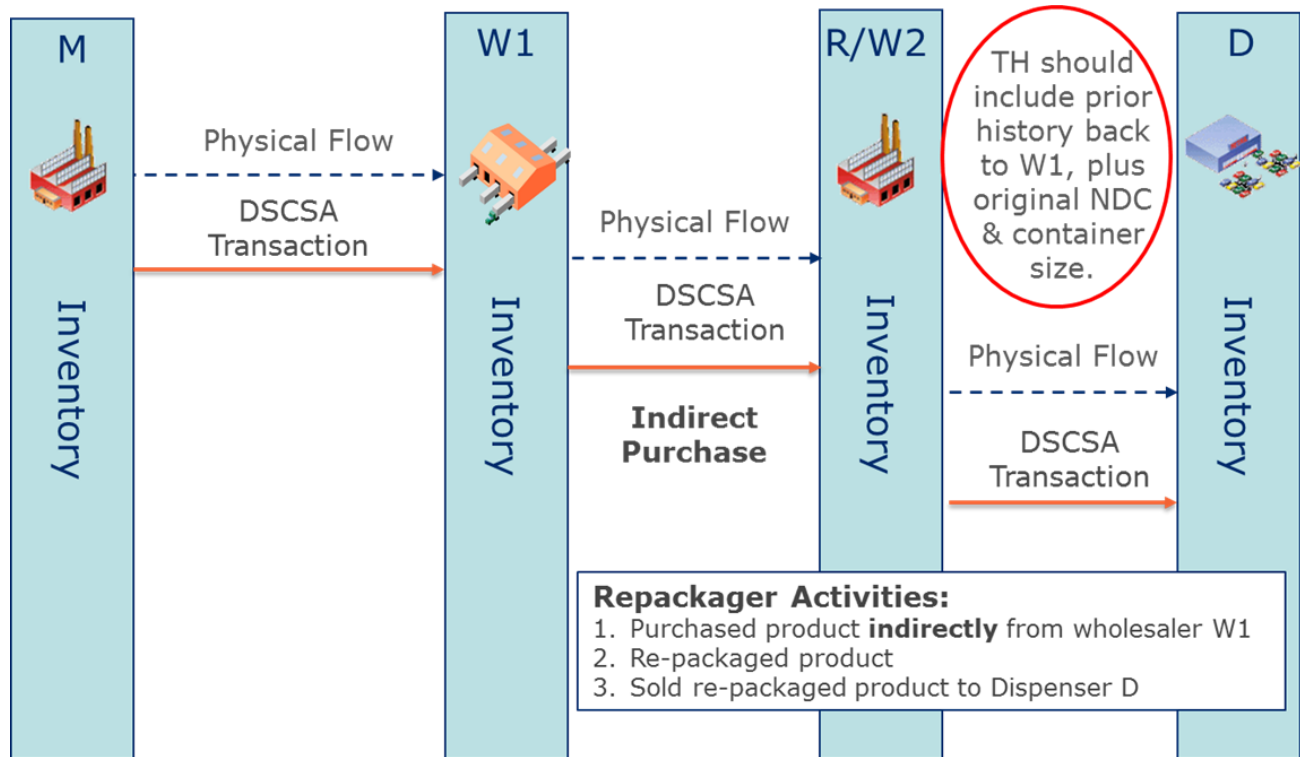

16.1 Sample XML: M → W1



Note: Because the manufacturer is the DSCSA transaction owner, the DSCSA transaction begins with the manufacturer. Therefore, the message content of the M → W1 transaction in this example is identical to the content of the M → W1 transaction in [Direct Purchase Example 1](#).

Reference File: https://resources.gs1us.org/Portals/0/xml/LotChoreo-RePackaging_Example4-MtoW1.xml

```
<?xml version="1.0" encoding="UTF-8" standalone="yes"?>
<!-- Lot Choreography End to End Examples: REPACKAGING - EXAMPLE 4: M->W1 -->
<!-- The M->W1 transaction in this example is identical to the M->W1 content for Direct
Purchase Example1 -->
<epcis:EPCISDocument xmlns:cbvmda="urn:epcglobal:cbv:mda"
xmlns:sbdh="http://www.unece.org/cefact/namespaces/StandardBusinessDocumentHeader"
xmlns:gs1ushc="http://epcis.gs1us.org/hc/ns" xmlns:epcis="urn:epcglobal:epcis:xsd:1"
schemaVersion="1.2" xsi:schemaLocation="urn:epcglobal:epcis:xsd:1 EPCglobal-epcis-1_2.xsd"
xmlns:xsi="http://www.w3.org/2001/XMLSchema-instance" creationDate="2014-05-30T15:14:27.574-
04:00">
  <EPCISHeader>
    <sbdh:StandardBusinessDocumentHeader>
      <sbdh:HeaderVersion>1.0</sbdh:HeaderVersion>
      <sbdh:Sender>
        <sbdh:Identifier
Authority="SGLN">urn:epc:id:sgln:030000.000000.0</sbdh:Identifier>
        </sbdh:Sender>
        <sbdh:Receiver>
          <sbdh:Identifier
Authority="SGLN">urn:epc:id:sgln:0614141.000000.0</sbdh:Identifier>
          </sbdh:Receiver>
        <sbdh:DocumentIdentification>
          <sbdh:Standard>EPCglobal</sbdh:Standard>
          <sbdh:TypeVersion>1.0</sbdh:TypeVersion>
          <sbdh:InstanceIdentifier>1234567890</sbdh:InstanceIdentifier>
          <sbdh:Type>Events</sbdh:Type>
          <sbdh:CreationDateAndTime>2014-05-30T15:14:27.574-04:00</sbdh:CreationDateAndTime>
        </sbdh:DocumentIdentification>
      </sbdh:StandardBusinessDocumentHeader>
      <extension>
        <EPCISMasterData>
          <VocabularyList>
            <Vocabulary type="urn:epcglobal:epcis:vtype:EPCClass">
              <VocabularyElementList>
                <VocabularyElement id="urn:epc:class:lgtin:030000.0000001.L1">
                  <attribute id="urn:epcglobal:cbv:mda#itemExpirationDate">2015-10-
31</attribute>
                </VocabularyElement>
                <VocabularyElement id="urn:epc:idpat:sgtin:030000.0000001.*">
                  <attribute
id="urn:epcglobal:cbv:mda#additionalTradeItemIdentification">00000000001</attribute>
                  <attribute
id="urn:epcglobal:cbv:mda#additionalTradeItemIdentificationTypeCode">FDA_NDC_11</attribute>
                  <attribute
id="urn:epcglobal:cbv:mda#regulatedProductName">Epcistra</attribute>
                  <attribute
id="urn:epcglobal:cbv:mda#manufacturerOfTradeItemPartyName">GS1 Pharma LLC</attribute>
                  <attribute id="urn:epcglobal:cbv:mda#dosageFormType">PILL</attribute>
                  <attribute
id="urn:epcglobal:cbv:mda#strengthDescription">100mg</attribute>
```



```

        <sourceList>
          <source
type="urn:epcglobal:cbv:sdt:owning_party">urn:epc:id:sgln:030000.000000.0</source>
        </sourceList>
        <destinationList>
          <destination
type="urn:epcglobal:cbv:sdt:owning_party">urn:epc:id:sgln:0614141.00000.0</destination>
        </destinationList>
      </extension>
    </ObjectEvent>
  </EventList>
</EPCISBody>
</epcis:EPCISDocument>

```

16.2 Sample XML: W1 → R/W2



Note: The message content of the W1 → R/W2 transaction in this example is identical to the content of the W1 → W2 transaction in [Extended Supply Chain Example 1](#).

Reference File: <https://resources.gs1us.org/Portals/0/xml/LotChoreo-RePackaging Example4-W1toRW2.xml>

```

<?xml version="1.0" encoding="UTF-8" standalone="yes"?>
<!-- Lot Choreography End to End Examples: REPACKAGING - EXAMPLE 4: W1->R/W2-->
<epcis:EPCISDocument xmlns:cbvmda="urn:epcglobal:cbv:mda"
xmlns:sbdh="http://www.unece.org/cefact/namespaces/StandardBusinessDocumentHeader"
xmlns:gslushc="http://epcis.gs1us.org/hc/ns" xmlns:epcis="urn:epcglobal:epcis:xsd:1"
schemaVersion="1.2" xsi:schemaLocation="urn:epcglobal:epcis:xsd:1 EPCglobal-epcis-1_2.xsd"
xmlns:xsi="http://www.w3.org/2001/XMLSchema-instance" creationDate="2014-05-30T15:14:27.574-
04:00">
  <EPCISHeader>
    <sbdh:StandardBusinessDocumentHeader>
      <sbdh:HeaderVersion>1.0</sbdh:HeaderVersion>
      <sbdh:Sender>
        <sbdh:Identifier
Authority="SGLN">urn:epc:id:sgln:0614141.00000.0</sbdh:Identifier>
      </sbdh:Sender>
      <sbdh:Receiver>
        <sbdh:Identifier
Authority="SGLN">urn:epc:id:sgln:0353579.00001.0</sbdh:Identifier>
      </sbdh:Receiver>
      <sbdh:DocumentIdentification>
        <sbdh:Standard>EPCglobal</sbdh:Standard>
        <sbdh:TypeVersion>1.0</sbdh:TypeVersion>
        <sbdh:InstanceIdentifier>1234567890</sbdh:InstanceIdentifier>
        <sbdh:Type>Events</sbdh:Type>
        <sbdh:CreationDateAndTime>2014-05-30T15:14:27.574-04:00</sbdh:CreationDateAndTime>
      </sbdh:DocumentIdentification>
    </sbdh:StandardBusinessDocumentHeader>
    <extension>
      <EPCISMasterData>
        <VocabularyList>
          <Vocabulary type="urn:epcglobal:epcis:vtype:EPCClass">
            <VocabularyElementList>
              <VocabularyElement id="urn:epc:idpat:sgtin:030000.0000001.*">
                <attribute
id="urn:epcglobal:cbv:mda#additionalTradeItemIdentification">00000000001</attribute>
                <attribute
id="urn:epcglobal:cbv:mda#additionalTradeItemIdentificationTypeCode">FDA_NDC_11</attribute>

```

```

        <attribute
id="urn:epcglobal:cbv:mda#manufacturerOfTradeItemPartyName">GS1 Pharma LLC</attribute>
        <attribute
id="urn:epcglobal:cbv:mda#regulatedProductName">Epcistra</attribute>
        <attribute id="urn:epcglobal:cbv:mda#dosageFormType">PILL</attribute>
        <attribute
id="urn:epcglobal:cbv:mda#strengthDescription">100mg</attribute>
        <attribute id="urn:epcglobal:cbv:mda#netContentDescription">500
pills</attribute>
    </VocabularyElement>
</VocabularyElementList>
</Vocabulary>
<Vocabulary type="urn:epcglobal:epcis:vtype:Location">
    <VocabularyElementList>
        <VocabularyElement id="urn:epc:id:sgln:030000.000000.0">
            <attribute id="urn:epcglobal:cbv:mda#name">GS1 Pharma LLC</attribute>
            <attribute id="urn:epcglobal:cbv:mda#streetAddressOne">1295 S George
Ave</attribute>
            <attribute id="urn:epcglobal:cbv:mda#streetAddressTwo">Room
378</attribute>
            <attribute id="urn:epcglobal:cbv:mda#city">Washington</attribute>
            <attribute id="urn:epcglobal:cbv:mda#state">DC</attribute>
            <attribute id="urn:epcglobal:cbv:mda#postalCode">12345-
6789</attribute>
            <attribute id="urn:epcglobal:cbv:mda#countryCode">US</attribute>
        </VocabularyElement>
        <VocabularyElement id="urn:epc:id:sgln:0614141.00000.0">
            <attribute id="urn:epcglobal:cbv:mda#name">GS1 Drug Distro
LLC</attribute>
            <attribute id="urn:epcglobal:cbv:mda#streetAddressOne">230 Park Ave
S</attribute>
            <attribute id="urn:epcglobal:cbv:mda#city">New York</attribute>
            <attribute id="urn:epcglobal:cbv:mda#state">NY</attribute>
            <attribute id="urn:epcglobal:cbv:mda#postalCode">10003-
1502</attribute>
            <attribute id="urn:epcglobal:cbv:mda#countryCode">US</attribute>
        </VocabularyElement>
        <VocabularyElement id="urn:epc:id:sgln:0353579.00001.0">
            <attribute id="urn:epcglobal:cbv:mda#name">GS1 Repackager and
Wholesaler</attribute>
            <attribute id="urn:epcglobal:cbv:mda#streetAddressOne">201 Broadway
Ave</attribute>
            <attribute id="urn:epcglobal:cbv:mda#streetAddressTwo">Bldg
10</attribute>
            <attribute id="urn:epcglobal:cbv:mda#city">Cambridge</attribute>
            <attribute id="urn:epcglobal:cbv:mda#state">MA</attribute>
            <attribute id="urn:epcglobal:cbv:mda#postalCode">02138</attribute>
            <attribute id="urn:epcglobal:cbv:mda#countryCode">US</attribute>
        </VocabularyElement>
    </VocabularyElementList>
</Vocabulary>
</VocabularyList>
</EPCISMasterData>
</extension>
<gslushc:dscsaTransactionStatement>
    <gslushc:affirmTransactionStatement>true</gslushc:affirmTransactionStatement>
    <gslushc:legalNotice>Seller has complied with each applicable subsection of FDCA Sec.
581(27)(A)-(G). As indicated below, product was purchased directly from the manufacturer,
manufacturer's exclusive distributor or repackager who purchased directly from a
manufacturer.</gslushc:legalNotice>
</gslushc:dscsaTransactionStatement>

```



```

</EPCISHeader>
<EPCISBody>
  <EventList>
    <!-- Transaction History (TH) -->
    <ObjectEvent>
      <eventTime>1970-01-01T00:00:00.000Z</eventTime>
      <eventTimeZoneOffset>+00:00</eventTimeZoneOffset>
      <epcList/>
      <action>OBSERVE</action>
      <bizStep>urn:epcglobal:cbv:bizstep:shipping</bizStep>
      <disposition>urn:epcglobal:cbv:disp:in_transit</disposition>
      <readPoint>
        <id>urn:epc:id:sgln:030000.000000.0</id>
      </readPoint>
      <extension>
        <quantityList>
          <quantityElement>
            <epcClass>urn:epc:idpat:sgtin:030000.0000001.*</epcClass>
            <quantity>100</quantity>
          </quantityElement>
        </quantityList>
        <sourceList>
          <source
type="urn:epcglobal:cbv:sdt:owning_party">urn:epc:id:sgln:030000.000000.0</source>
          </sourceList>
        <destinationList>
          <destination
type="urn:epcglobal:cbv:sdt:owning_party">urn:epc:id:sgln:0614141.00000.0</destination>
          </destinationList>
        </extension>
      </ObjectEvent>
    <!-- Transaction Information (TI) -->
    <ObjectEvent>
      <eventTime>2014-04-01T11:00:00.000-04:00</eventTime>
      <eventTimeZoneOffset>-04:00</eventTimeZoneOffset>
      <epcList/>
      <action>OBSERVE</action>
      <bizStep>urn:epcglobal:cbv:bizstep:shipping</bizStep>
      <disposition>urn:epcglobal:cbv:disp:in_transit</disposition>
      <readPoint>
        <id>urn:epc:id:sgln:0614141.00000.0</id>
      </readPoint>
      <extension>
        <quantityList>
          <quantityElement>
            <epcClass>urn:epc:idpat:sgtin:030000.0000001.*</epcClass>
            <quantity>100</quantity>
          </quantityElement>
        </quantityList>
        <sourceList>
          <source
type="urn:epcglobal:cbv:sdt:owning_party">urn:epc:id:sgln:0614141.00000.0</source>
          </sourceList>
        <destinationList>
          <destination
type="urn:epcglobal:cbv:sdt:owning_party">urn:epc:id:sgln:0353579.00001.0</destination>
          </destinationList>
        <gslushc:directPurchase value="true"/>
      </extension>
    </ObjectEvent>
  </EventList>

```

```
</EPCISBody>
</epcis:EPCISDocument>
```

16.3 Sample XML: R/W2 → D

Reference File: https://resources.gs1us.org/Portals/0/xml/LotChoreo-RePackaging_Example4-RW2toD.xml

```
<?xml version="1.0" encoding="UTF-8" standalone="yes"?>
<!-- Lot Choreography End to End Examples: REPACKAGING - EXAMPLE 4: R/W2->D -->
<epcis:EPCISDocument xmlns:cbvmda="urn:epcglobal:cbv:mda"
xmlns:sbdh="http://www.unece.org/cefact/namespaces/StandardBusinessDocumentHeader"
xmlns:gslushc="http://epcis.gs1us.org/hc/ns" xmlns:epcis="urn:epcglobal:epcis:xsd:1"
schemaVersion="1.2" xsi:schemaLocation="urn:epcglobal:epcis:xsd:1 EPCglobal-epcis-1_2.xsd"
xmlns:xsi="http://www.w3.org/2001/XMLSchema-instance" creationDate="2014-06-02T15:14:27.574-04:00">
  <EPCISHeader>
    <sbdh:StandardBusinessDocumentHeader>
      <sbdh:HeaderVersion>1.0</sbdh:HeaderVersion>
      <sbdh:Sender>
        <sbdh:Identifier
Authority="SGLN">urn:epc:id:sgln:0353579.00001.0</sbdh:Identifier>
        </sbdh:Sender>
      <sbdh:Receiver>
        <sbdh:Identifier
Authority="SGLN">urn:epc:id:sgln:5012345.00000.0</sbdh:Identifier>
        </sbdh:Receiver>
      <sbdh:DocumentIdentification>
        <sbdh:Standard>EPCglobal</sbdh:Standard>
        <sbdh:TypeVersion>1.0</sbdh:TypeVersion>
        <sbdh:InstanceIdentifier>1234567890</sbdh:InstanceIdentifier>
        <sbdh:Type>Events</sbdh:Type>
        <sbdh:CreationDateAndTime>2014-06-02T15:14:27.574-04:00</sbdh:CreationDateAndTime>
      </sbdh:DocumentIdentification>
    </sbdh:StandardBusinessDocumentHeader>
    <extension>
      <EPCISMasterData>
        <VocabularyList>
          <Vocabulary type="urn:epcglobal:epcis:vtype:EPCClass">
            <VocabularyElementList>
              <VocabularyElement id="urn:epc:idpat:sgtin:030000.0000001.*">
                <attribute
id="urn:epcglobal:cbv:mda#additionalTradeItemIdentification">00000000001</attribute>
                <attribute
id="urn:epcglobal:cbv:mda#additionalTradeItemIdentificationTypeCode">FDA_NDC_11</attribute>
                <attribute
id="urn:epcglobal:cbv:mda#manufacturerOfTradeItemPartyName">GS1 Pharma LLC</attribute>
                <attribute
id="urn:epcglobal:cbv:mda#regulatedProductName">Epcistra</attribute>
                <attribute id="urn:epcglobal:cbv:mda#dosageFormType">PILL</attribute>
                <attribute
id="urn:epcglobal:cbv:mda#strengthDescription">100mg</attribute>
                <attribute id="urn:epcglobal:cbv:mda#netContentDescription">500
pills</attribute>
              </VocabularyElement>
              <VocabularyElement id="urn:epc:idpat:sgtin:0353579.012610.*">
                <attribute
id="urn:epcglobal:cbv:mda#additionalTradeItemIdentification">53579012610</attribute>
                <attribute
id="urn:epcglobal:cbv:mda#additionalTradeItemIdentificationTypeCode">FDA_NDC_11</attribute>
```

```

        <attribute
id="urn:epcglobal:cbv:mda#regulatedProductName">REpcistra</attribute>
        <attribute
id="urn:epcglobal:cbv:mda#manufacturerOfTradeItemPartyName">GS1 Repackager LLC</attribute>
        <attribute id="urn:epcglobal:cbv:mda#dosageFormType">PILL</attribute>
        <attribute
id="urn:epcglobal:cbv:mda#strengthDescription">100mg</attribute>
        <attribute id="urn:epcglobal:cbv:mda#netContentDescription">250
pills</attribute>
    </VocabularyElement>
</VocabularyElementList>
</Vocabulary>
<Vocabulary type="urn:epcglobal:epcis:vtype:Location">
    <VocabularyElementList>
        <VocabularyElement id="urn:epc:id:sgln:030000.000000.0">
            <attribute id="urn:epcglobal:cbv:mda#name">GS1 Pharma LLC</attribute>
            <attribute id="urn:epcglobal:cbv:mda#streetAddressOne">1295 S George
Ave</attribute>
            <attribute id="urn:epcglobal:cbv:mda#streetAddressTwo">Room
378</attribute>
            <attribute id="urn:epcglobal:cbv:mda#city">Washington</attribute>
            <attribute id="urn:epcglobal:cbv:mda#state">DC</attribute>
            <attribute id="urn:epcglobal:cbv:mda#postalCode">12345-
6789</attribute>
            <attribute id="urn:epcglobal:cbv:mda#countryCode">US</attribute>
        </VocabularyElement>
        <VocabularyElement id="urn:epc:id:sgln:0353579.00001.0">
            <attribute id="urn:epcglobal:cbv:mda#name">GS1 Repackager
LLC</attribute>
            <attribute id="urn:epcglobal:cbv:mda#streetAddressOne">201 Broadway
Ave</attribute>
            <attribute id="urn:epcglobal:cbv:mda#streetAddressTwo">Bldg
10</attribute>
            <attribute id="urn:epcglobal:cbv:mda#city">Cambridge</attribute>
            <attribute id="urn:epcglobal:cbv:mda#state">MA</attribute>
            <attribute id="urn:epcglobal:cbv:mda#postalCode">02138</attribute>
            <attribute id="urn:epcglobal:cbv:mda#countryCode">US</attribute>
        </VocabularyElement>
        <VocabularyElement id="urn:epc:id:sgln:0614141.00000.0">
            <attribute id="urn:epcglobal:cbv:mda#name">GS1 Drug Distro
LLC</attribute>
            <attribute id="urn:epcglobal:cbv:mda#streetAddressOne">230 Park Ave
S</attribute>
            <attribute id="urn:epcglobal:cbv:mda#city">New York</attribute>
            <attribute id="urn:epcglobal:cbv:mda#state">NY</attribute>
            <attribute id="urn:epcglobal:cbv:mda#postalCode">10003-
1502</attribute>
            <attribute id="urn:epcglobal:cbv:mda#countryCode">US</attribute>
        </VocabularyElement>
        <VocabularyElement id="urn:epc:id:sgln:5012345.00000.0">
            <attribute id="urn:epcglobal:cbv:mda#name">GS1 Pere et Fils
Pharmacy</attribute>
            <attribute id="urn:epcglobal:cbv:mda#streetAddressOne">1313
Mockingbird Lane</attribute>
            <attribute id="urn:epcglobal:cbv:mda#city">Paris</attribute>
            <attribute id="urn:epcglobal:cbv:mda#state">TX</attribute>
            <attribute id="urn:epcglobal:cbv:mda#postalCode">76543</attribute>
            <attribute id="urn:epcglobal:cbv:mda#countryCode">US</attribute>
        </VocabularyElement>
    </VocabularyElementList>
</Vocabulary>

```

```

        </VocabularyList>
    </EPCISMasterData>
</extension>
<gslushc:dscsaTransactionStatement>
    <gslushc:affirmTransactionStatement>true</gslushc:affirmTransactionStatement>
    <gslushc:legalNotice>Seller has complied with each applicable subsection of FDCA Sec.
581(27)(A)-(G). As indicated below, product was purchased directly from the manufacturer,
manufacturer's exclusive distributor or repackager who purchased directly from a
manufacturer.</gslushc:legalNotice>
</gslushc:dscsaTransactionStatement>
</EPCISHeader>
<EPCISBody>
    <EventList>
        <!-- Transaction History (TH) for M to W1 -->
        <ObjectEvent>
            <eventTime>1970-01-01T00:00:00.000Z</eventTime>
            <eventTimeZoneOffset>+00:00</eventTimeZoneOffset>
            <epcList/>
            <action>OBSERVE</action>
            <bizStep>urn:epcglobal:cbv:bizstep:shipping</bizStep>
            <disposition>urn:epcglobal:cbv:disp:in_transit</disposition>
            <readPoint>
                <id>urn:epc:id:sgln:030000.000000.0</id>
            </readPoint>
            <extension>
                <quantityList>
                    <quantityElement>
                        <epcClass>urn:epc:class:lgtn:030000.0000001.L1</epcClass>
                        <quantity>100</quantity>
                    </quantityElement>
                </quantityList>
                <sourceList>
                    <source
type="urn:epcglobal:cbv:sdt:owning_party">urn:epc:id:sgln:030000.000000.0</source>
                    </sourceList>
                <destinationList>
                    <destination
type="urn:epcglobal:cbv:sdt:owning_party">urn:epc:id:sgln:0614141.00000.0</destination>
                    </destinationList>
                </extension>
            </ObjectEvent>
        <!-- Transaction History (TH) of sale for W1 to R/W2 -->
        <ObjectEvent>
            <eventTime>2014-04-01T11:00:00.000-04:00</eventTime>
            <eventTimeZoneOffset>-04:00</eventTimeZoneOffset>
            <epcList/>
            <action>OBSERVE</action>
            <bizStep>urn:epcglobal:cbv:bizstep:shipping</bizStep>
            <disposition>urn:epcglobal:cbv:disp:in_transit</disposition>
            <readPoint>
                <id>urn:epc:id:sgln:0614141.00000.0</id>
            </readPoint>
            <extension>
                <quantityList>
                    <quantityElement>
                        <epcClass>urn:epc:class:lgtn:030000.0000001.L1</epcClass>
                        <quantity>100</quantity>
                    </quantityElement>
                </quantityList>
                <sourceList>

```



```
</extension>

  <gslushc:receivedADirectPurchaseStatementFromPreviousWholesaleDistributor>true</gslushc:receivedADirectPurchaseStatementFromPreviousWholesaleDistributor>
    </ObjectEvent>
  </EventList>
</EPCISBody>
</epcis:EPCISDocument>
```

17 340B Contract Pharmacy Scenario – Example 1

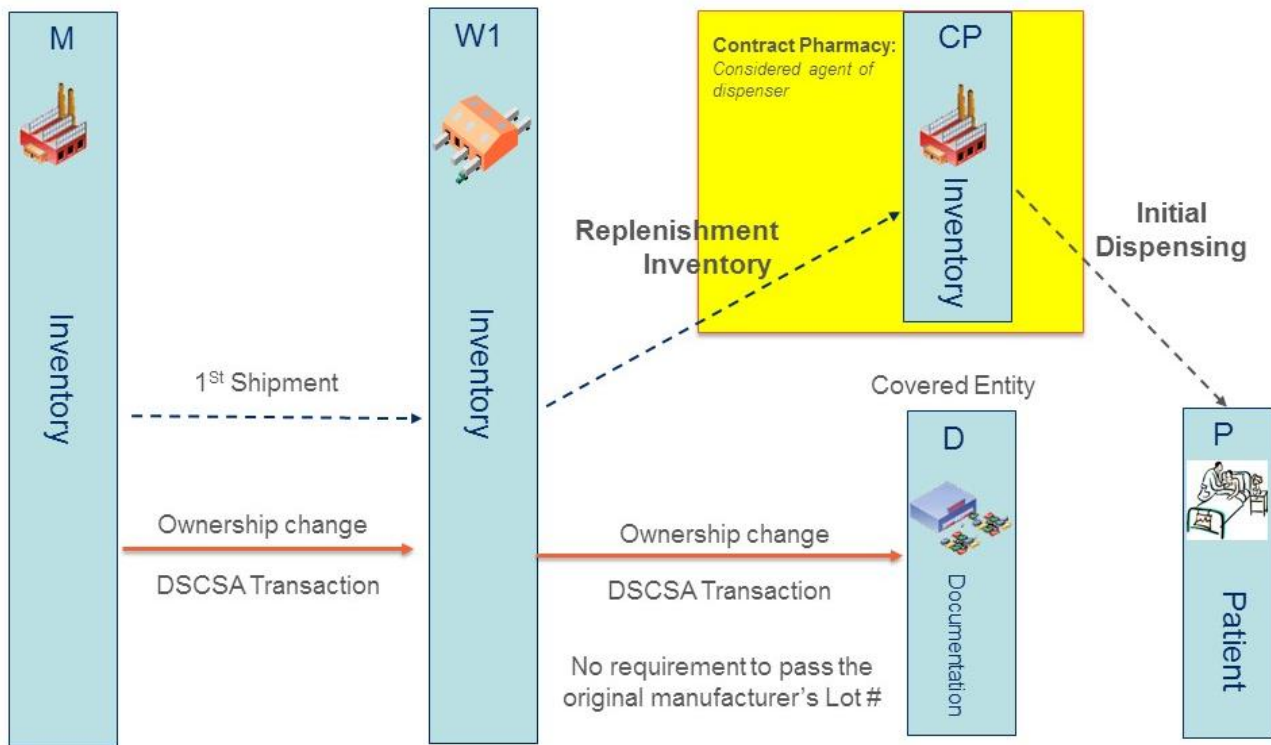

17.1 Sample XML: M → W1



Note: Because the manufacturer is the DSCSA transaction owner, the DSCSA transaction begins with the manufacturer. Therefore, the message content of the M → W1 transaction in this example is identical to the content of the M → W1 transaction in [Direct Purchase Example 1](#).

Reference File: <https://resources.gs1us.org/Portals/0/xml/LotChoreo-Contract Pharmacy340B Example-MtoW1.xml>

```
<?xml version="1.0" encoding="UTF-8" standalone="yes"?>
<!-- Lot Choreography End to End Examples: 340B CONTRACT PHARMACY - EXAMPLE 1: M->W1 -->
<!-- The M->W1 transaction in this example is identical to the M->W1 content for Direct
Purchase Example1 -->
<epcis:EPCISDocument xmlns:cbvmda="urn:epcglobal:cbv:mda"
xmlns:sbdh="http://www.unece.org/cefact/namespaces/StandardBusinessDocumentHeader"
xmlns:gslushc="http://epcis.gs1us.org/hc/ns" xmlns:epcis="urn:epcglobal:epcis:xsd:1"
schemaVersion="1.2" xsi:schemaLocation="urn:epcglobal:epcis:xsd:1 EPCglobal-epcis-1_2.xsd"
xmlns:xsi="http://www.w3.org/2001/XMLSchema-instance" creationDate="2014-05-30T15:14:27.574-
04:00">
  <EPCISHeader>
    <sbdh:StandardBusinessDocumentHeader>
      <sbdh:HeaderVersion>1.0</sbdh:HeaderVersion>
      <sbdh:Sender>
        <sbdh:Identifier
Authority="SGLN">urn:epc:id:sgln:030000.000000.0</sbdh:Identifier>
      </sbdh:Sender>
      <sbdh:Receiver>
        <sbdh:Identifier
Authority="SGLN">urn:epc:id:sgln:0614141.00000.0</sbdh:Identifier>
      </sbdh:Receiver>
      <sbdh:DocumentIdentification>
        <sbdh:Standard>EPCglobal</sbdh:Standard>
        <sbdh:TypeVersion>1.0</sbdh:TypeVersion>
        <sbdh:InstanceIdentifier>1234567890</sbdh:InstanceIdentifier>
        <sbdh:Type>Events</sbdh:Type>
        <sbdh:CreationDateAndTime>2014-05-30T15:14:27.574-04:00</sbdh:CreationDateAndTime>
      </sbdh:DocumentIdentification>
    </sbdh:StandardBusinessDocumentHeader>
    <extension>
      <EPCISMasterData>
        <VocabularyList>
          <Vocabulary type="urn:epcglobal:epcis:vtype:EPCClass">
            <VocabularyElementList>
              <VocabularyElement id="urn:epc:class:lgtin:030000.0000001.L1">
                <attribute id="urn:epcglobal:cbv:mda#itemExpirationDate">2015-10-
31</attribute>
              </VocabularyElement>
              <VocabularyElement id="urn:epc:idpat:sgtin:030000.0000001.*">
                <attribute
id="urn:epcglobal:cbv:mda#additionalTradeItemIdentification">00000000001</attribute>
                <attribute
id="urn:epcglobal:cbv:mda#additionalTradeItemIdentificationTypeCode">FDA_NDC_11</attribute>
                <attribute
id="urn:epcglobal:cbv:mda#regulatedProductName">Epcistra</attribute>
                <attribute
id="urn:epcglobal:cbv:mda#manufacturerOfTradeItemPartyName">GS1 Pharma LLC</attribute>
                <attribute id="urn:epcglobal:cbv:mda#dosageFormType">PILL</attribute>
                <attribute
id="urn:epcglobal:cbv:mda#strengthDescription">100mg</attribute>
              </VocabularyElement>
            </VocabularyElementList>
          </Vocabulary>
        </EPCISMasterData>
      </extension>
    </EPCISHeader>
  </EPCISDocument>

```



```

        <sourceList>
          <source
type="urn:epcglobal:cbv:sdt:owning_party">urn:epc:id:sgln:030000.000000.0</source>
        </sourceList>
        <destinationList>
          <destination
type="urn:epcglobal:cbv:sdt:owning_party">urn:epc:id:sgln:0614141.00000.0</destination>
        </destinationList>
      </extension>
    </ObjectEvent>
  </EventListener>
</EPCISBody>
</epcis:EPCISDocument>

```

17.2 Sample XML: W1 → D



Note: Because the wholesaler is transferring ownership to the covered entity (the Dispenser), the message content of the W1 → D transaction in this example is identical to the content of the W1 → D in the [Direct Purchase Example 1](#).

Reference File: <https://resources.gs1us.org/Portals/0/xml/LotChoreo-Contract Pharmacy340B Example-W1toD.xml>

```

<?xml version="1.0" encoding="UTF-8" standalone="yes"?>
<!-- Lot Choreography End to End Examples: 340B CONTRACT PHARMACY - EXAMPLE 1: W1->D -->
<!-- The W1->D transaction in this example is identical to the W1->D content for Direct
Purchase Example1 -->
<epcis:EPCISDocument xmlns:cbvmda="urn:epcglobal:cbv:mda"
xmlns:sbdh="http://www.unece.org/cefact/namespaces/StandardBusinessDocumentHeader"
xmlns:gslushc="http://epcis.gs1us.org/hc/ns" xmlns:epcis="urn:epcglobal:epcis:xsd:1"
schemaVersion="1.2" xsi:schemaLocation="urn:epcglobal:epcis:xsd:1 EPCglobal-epcis-1_2.xsd"
xmlns:xsi="http://www.w3.org/2001/XMLSchema-instance" creationDate="2014-05-30T15:14:27.574-
04:00">
  <EPCISHeader>
    <sbdh:StandardBusinessDocumentHeader>
      <sbdh:HeaderVersion>1.0</sbdh:HeaderVersion>
      <sbdh:Sender>
        <sbdh:Identifier
Authority="SGLN">urn:epc:id:sgln:0614141.00000.0</sbdh:Identifier>
      </sbdh:Sender>
      <sbdh:Receiver>
        <sbdh:Identifier
Authority="SGLN">urn:epc:id:sgln:5012345.00000.0</sbdh:Identifier>
      </sbdh:Receiver>
      <sbdh:DocumentIdentification>
        <sbdh:Standard>EPCglobal</sbdh:Standard>
        <sbdh:TypeVersion>1.0</sbdh:TypeVersion>
        <sbdh:InstanceIdentifier>1234567890</sbdh:InstanceIdentifier>
        <sbdh:Type>Events</sbdh:Type>
        <sbdh:CreationDateAndTime>2014-05-30T15:14:27.574-04:00</sbdh:CreationDateAndTime>
      </sbdh:DocumentIdentification>
    </sbdh:StandardBusinessDocumentHeader>
    <extension>
      <EPCISMasterData>
        <VocabularyList>
          <Vocabulary type="urn:epcglobal:epcis:vtype:EPCClass">
            <VocabularyElementList>
              <VocabularyElement id="urn:epc:idpat:sgtin:030000.0000001.*">

```

```

        <attribute
id="urn:epcglobal:cbv:mda#additionalTradeItemIdentification">0000000001</attribute>
        <attribute
id="urn:epcglobal:cbv:mda#additionalTradeItemIdentificationTypeCode">FDA_NDC_11</attribute>
        <attribute
id="urn:epcglobal:cbv:mda#regulatedProductName">Epcistra</attribute>
        <attribute
id="urn:epcglobal:cbv:mda#manufacturerOfTradeItemPartyName">GS1 Pharma LLC</attribute>
        <attribute id="urn:epcglobal:cbv:mda#dosageFormType">PILL</attribute>
        <attribute
id="urn:epcglobal:cbv:mda#strengthDescription">100mg</attribute>
        <attribute id="urn:epcglobal:cbv:mda#netContentDescription">500
pills</attribute>
    </VocabularyElement>
</VocabularyElementList>
</Vocabulary>
<Vocabulary type="urn:epcglobal:epcis:vtype:Location">
    <VocabularyElementList>
        <VocabularyElement id="urn:epc:id:sgln:030000.000000.0">
            <attribute id="urn:epcglobal:cbv:mda#name">GS1 Pharma LLC</attribute>
            <attribute id="urn:epcglobal:cbv:mda#streetAddressOne">1295 S George
Ave</attribute>
            <attribute id="urn:epcglobal:cbv:mda#streetAddressTwo">Room
378</attribute>
            <attribute id="urn:epcglobal:cbv:mda#city">Washington</attribute>
            <attribute id="urn:epcglobal:cbv:mda#state">DC</attribute>
            <attribute id="urn:epcglobal:cbv:mda#postalCode">12345-
6789</attribute>
            <attribute id="urn:epcglobal:cbv:mda#countryCode">US</attribute>
        </VocabularyElement>
        <VocabularyElement id="urn:epc:id:sgln:0614141.000000.0">
            <attribute id="urn:epcglobal:cbv:mda#name">GS1 Drug Distro
LLC</attribute>
            <attribute id="urn:epcglobal:cbv:mda#streetAddressOne">230 Park Ave
S</attribute>
            <attribute id="urn:epcglobal:cbv:mda#city">New York</attribute>
            <attribute id="urn:epcglobal:cbv:mda#state">NY</attribute>
            <attribute id="urn:epcglobal:cbv:mda#postalCode">10003-
1502</attribute>
            <attribute id="urn:epcglobal:cbv:mda#countryCode">US</attribute>
        </VocabularyElement>
    </VocabularyElementList>
</Vocabulary>
</EPCISMasterData>
</extension>
<gslushc:dscsaTransactionStatement>
    <gslushc:affirmTransactionStatement>true</gslushc:affirmTransactionStatement>
    <gslushc:legalNotice>Seller has complied with each applicable subsection of FDCA Sec.
581(27)(A)-(G). As indicated below, product was purchased directly from the manufacturer,

```

```

manufacturer's exclusive distributor or repackager who purchased directly from a
manufacturer.</gslushc:legalNotice>
  </gslushc:dscsaTransactionStatement>
</EPCISHeader>
<EPCISBody>
  <EventList>
    <!-- Transaction History (TH) -->
    <ObjectEvent>
      <eventTime>1970-01-01T00:00:00.000Z</eventTime>
      <eventTimeZoneOffset>+00:00</eventTimeZoneOffset>
      <epcList/>
      <action>OBSERVE</action>
      <bizStep>urn:epcglobal:cbv:bizstep:shipping</bizStep>
      <disposition>urn:epcglobal:cbv:disp:in_transit</disposition>
      <readPoint>
        <id>urn:epc:id:sgln:030000.000000.0</id>
      </readPoint>
      <extension>
        <quantityList>
          <quantityElement>
            <epcClass>urn:epc:idpat:sgtin:030000.0000001.*</epcClass>
            <quantity>50</quantity>
          </quantityElement>
        </quantityList>
        <sourceList>
          <source
type="urn:epcglobal:cbv:sdt:owning_party">urn:epc:id:sgln:030000.000000.0</source>
          </sourceList>
          <destinationList>
            <destination
type="urn:epcglobal:cbv:sdt:owning_party">urn:epc:id:sgln:0614141.00000.0</destination>
            </destinationList>
          </extension>
        </ObjectEvent>
    <!-- Transaction Information (TI) -->
    <ObjectEvent>
      <eventTime>2014-04-05T11:00:00.000-04:00</eventTime>
      <eventTimeZoneOffset>-04:00</eventTimeZoneOffset>
      <epcList/>
      <action>OBSERVE</action>
      <bizStep>urn:epcglobal:cbv:bizstep:shipping</bizStep>
      <disposition>urn:epcglobal:cbv:disp:in_transit</disposition>
      <readPoint>
        <id>urn:epc:id:sgln:0614141.00000.0</id>
      </readPoint>
      <extension>
        <quantityList>
          <quantityElement>
            <epcClass>urn:epc:idpat:sgtin:030000.0000001.*</epcClass>
            <quantity>50</quantity>
          </quantityElement>
        </quantityList>
        <sourceList>
          <source
type="urn:epcglobal:cbv:sdt:owning_party">urn:epc:id:sgln:0614141.00000.0</source>
          </sourceList>
          <destinationList>
            <destination
type="urn:epcglobal:cbv:sdt:owning_party">urn:epc:id:sgln:5012345.00000.0</destination>
            </destinationList>
          </extension>

```

```
        <gslushc:directPurchase value="true"/>
    </ObjectEvent>
</EventList>
</EPCISBody>
</epcis:EPCISDocument>
```

18 Third Party Logistics Scenario – Example 1

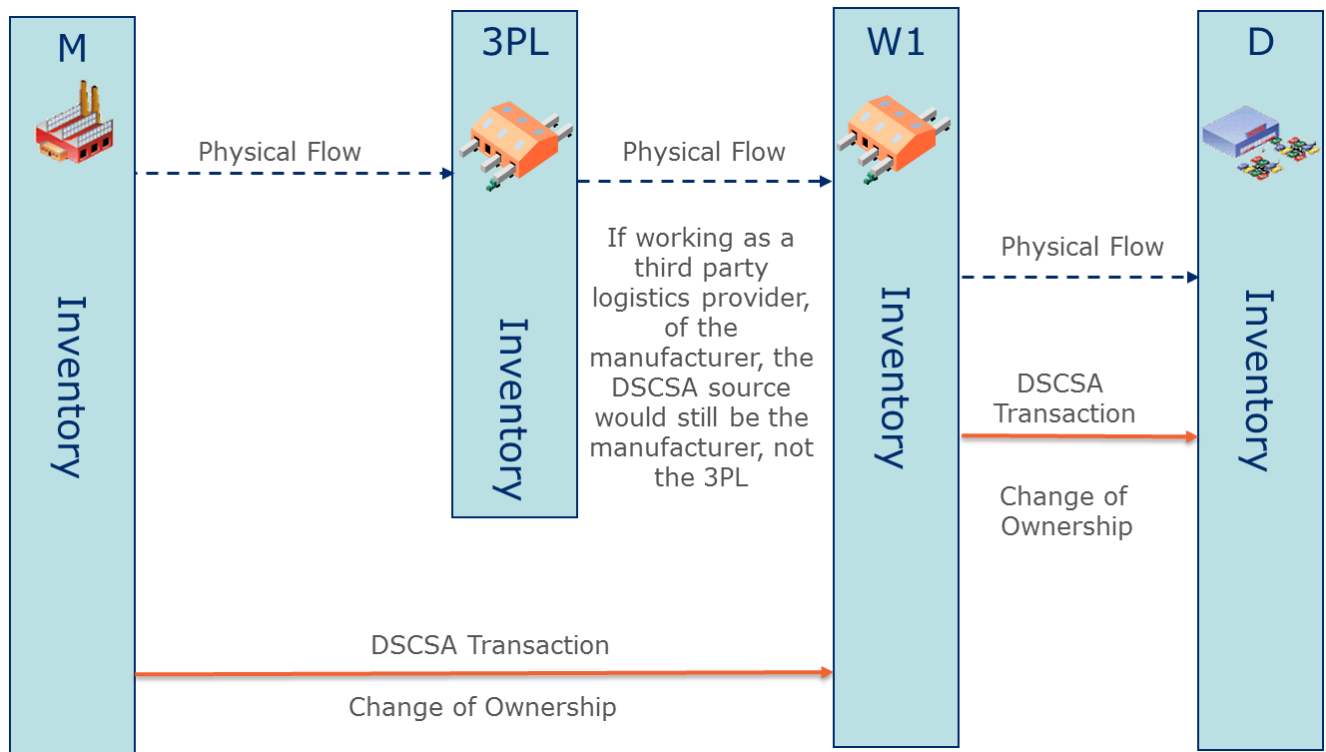

18.1 Sample XML: M → W1

 **Note:** While the 3PL is involved in transferring physical possession of the products, the manufacturer is the DSCSA transaction owner who initiates the DSCSA transaction. Therefore, the message content of the M → W1 transaction in this example is similar to the content of the M → W1 transaction in the [Direct Purchase Example 1](#) except that the readPoint of the *Shipping* event is set to the 3PL's sGLN.

Reference File: <https://resources.gs1us.org/Portals/0/xml/LotChoreo-3PL Example-MtoW1.xml>

```
<?xml version="1.0" encoding="UTF-8" standalone="yes"?>
<!-- Lot Choreography End to End Examples: 3PL - EXAMPLE 1: M->W1 -->
<epcis:EPCISDocument xmlns:cbvmda="urn:epcglobal:cbv:mda"
xmlns:sbdh="http://www.unece.org/cefact/namespaces/StandardBusinessDocumentHeader"
xmlns:gslushc="http://epcis.gs1us.org/hc/ns" xmlns:epcis="urn:epcglobal:epcis:xsd:1"
schemaVersion="1.2" xsi:schemaLocation="urn:epcglobal:epcis:xsd:1 EPCglobal-epcis-1_2.xsd"
xmlns:xsi="http://www.w3.org/2001/XMLSchema-instance" creationDate="2014-05-30T15:14:27.574-
04:00">
  <EPCISHeader>
    <sbdh:StandardBusinessDocumentHeader>
      <sbdh:HeaderVersion>1.0</sbdh:HeaderVersion>
      <sbdh:Sender>
        <sbdh:Identifier
Authority="SGLN">urn:epc:id:sgln:030000.000000.0</sbdh:Identifier>
        </sbdh:Sender>
        <sbdh:Receiver>
          <sbdh:Identifier
Authority="SGLN">urn:epc:id:sgln:0614141.00000.0</sbdh:Identifier>
          </sbdh:Receiver>
          <sbdh:DocumentIdentification>
            <sbdh:Standard>EPCglobal</sbdh:Standard>
            <sbdh:TypeVersion>1.0</sbdh:TypeVersion>
            <sbdh:InstanceIdentifier>1234567890</sbdh:InstanceIdentifier>
            <sbdh:Type>Events</sbdh:Type>
            <sbdh:CreationDateAndTime>2014-05-30T15:14:27.574-04:00</sbdh:CreationDateAndTime>
          </sbdh:DocumentIdentification>
        </sbdh:StandardBusinessDocumentHeader>
        <extension>
          <EPCISMasterData>
            <VocabularyList>
              <Vocabulary type="urn:epcglobal:epcis:vtype:EPCClass">
                <VocabularyElementList>
                  <VocabularyElement id="urn:epc:class:lgtin:030000.0000001.L1">
                    <attribute id="urn:epcglobal:cbv:mda#itemExpirationDate">2015-10-
31</attribute>
                  </VocabularyElement>
                  <VocabularyElement id="urn:epc:idpat:sgtin:030000.0000001.*">
                    <attribute
id="urn:epcglobal:cbv:mda#additionalTradeItemIdentification">0000000001</attribute>
                    <attribute
id="urn:epcglobal:cbv:mda#additionalTradeItemIdentificationTypeCode">FDA_NDC_11</attribute>
                    <attribute
id="urn:epcglobal:cbv:mda#regulatedProductName">Epcistra</attribute>
                    <attribute
id="urn:epcglobal:cbv:mda#manufacturerOfTradeItemPartyName">GS1 Pharma LLC</attribute>
                    <attribute id="urn:epcglobal:cbv:mda#dosageFormType">PILL</attribute>
                    <attribute
id="urn:epcglobal:cbv:mda#strengthDescription">100mg</attribute>
```

```

                    <attribute id="urn:epcglobal:cbv:mda#netContentDescription">500
pills</attribute>
                </VocabularyElement>
            </VocabularyElementList>
        </Vocabulary>
        <Vocabulary type="urn:epcglobal:epcis:vtype:Location">
            <VocabularyElementList>
                <VocabularyElement id="urn:epc:id:sgln:030000.000000.0">
                    <attribute id="urn:epcglobal:cbv:mda#name">GS1 Pharma LLC</attribute>
                    <attribute id="urn:epcglobal:cbv:mda#streetAddressOne">1295 S George
Ave</attribute>
                    <attribute id="urn:epcglobal:cbv:mda#streetAddressTwo">Room
378</attribute>
                    <attribute id="urn:epcglobal:cbv:mda#city">Washington</attribute>
                    <attribute id="urn:epcglobal:cbv:mda#state">DC</attribute>
                    <attribute id="urn:epcglobal:cbv:mda#postalCode">12345-
6789</attribute>
                    <attribute id="urn:epcglobal:cbv:mda#countryCode">US</attribute>
                </VocabularyElement>
                <VocabularyElement id="urn:epc:id:sgln:0724142.00001.0">
                    <attribute id="urn:epcglobal:cbv:mda#name">GS1 3PL LLC</attribute>
                    <attribute id="urn:epcglobal:cbv:mda#streetAddressOne">230 Madison
Ave S</attribute>
                    <attribute id="urn:epcglobal:cbv:mda#city">New York</attribute>
                    <attribute id="urn:epcglobal:cbv:mda#state">NY</attribute>
                    <attribute id="urn:epcglobal:cbv:mda#postalCode">10003-
1502</attribute>
                    <attribute id="urn:epcglobal:cbv:mda#countryCode">US</attribute>
                </VocabularyElement>
            </VocabularyElementList>
        </Vocabulary>
        <VocabularyElement id="urn:epc:id:sgln:0614141.00000.0">
            <attribute id="urn:epcglobal:cbv:mda#name">GS1 Drug Distro
LLC</attribute>
            <attribute id="urn:epcglobal:cbv:mda#streetAddressOne">230 Park Ave
S</attribute>
            <attribute id="urn:epcglobal:cbv:mda#city">New York</attribute>
            <attribute id="urn:epcglobal:cbv:mda#state">NY</attribute>
            <attribute id="urn:epcglobal:cbv:mda#postalCode">10003-
1502</attribute>
            <attribute id="urn:epcglobal:cbv:mda#countryCode">US</attribute>
        </VocabularyElement>
    </VocabularyElementList>
</Vocabulary>
</VocabularyList>
</EPCISMasterData>
</extension>
<gslushc:dscsaTransactionStatement>
    <gslushc:affirmTransactionStatement>true</gslushc:affirmTransactionStatement>
    <gslushc:legalNotice>Seller has complied with each applicable subsection of FDCA Sec.
581 (27) (A) - (G).</gslushc:legalNotice>
</gslushc:dscsaTransactionStatement>
</EPCISHeader>
<EPCISBody>
    <EventList>
        <!-- Transaction Information (TI) -->
        <ObjectEvent>
            <eventTime>2014-04-01T10:11:12Z</eventTime>
            <eventTimeZoneOffset>-05:00</eventTimeZoneOffset>
            <epcList/>
            <action>OBSERVE</action>
            <bizStep>urn:epcglobal:cbv:bizstep:shipping</bizStep>
            <disposition>urn:epcglobal:cbv:disp:in_transit</disposition>

```



```

    <!-- Since the 3PL is performing shipping service for the manufacturer, the
shipping event readPoint is set to the 3PL's sGLN -->
    <readPoint>
      <id>urn:epc:id:sgln:0724142.00001.0</id>
    </readPoint>
    <extension>
      <quantityList>
        <quantityElement>
          <epcClass>urn:epc:class:lgtn:030000.0000001.L1</epcClass>
          <quantity>100</quantity>
        </quantityElement>
      </quantityList>
    </sourceList>
    <sourceList>
      <!-- Since the manufacturer owns the product, the source owning party is
the manufacturer's sGLN -->
      <source
type="urn:epcglobal:cbv:sdt:owning_party">urn:epc:id:sgln:030000.000000.0</source>
    </sourceList>
    <destinationList>
      <destination
type="urn:epcglobal:cbv:sdt:owning_party">urn:epc:id:sgln:0614141.00000.0</destination>
    </destinationList>
  </extension>
</ObjectEvent>
</EventList>
</EPCISBody>
</epcis:EPCISDocument>

```

18.2 Sample XML: W1 → D



Note: The message content of the DSCSA transaction for W1 → D in this example is similar to the content of the W1 → D in the [Direct Purchase Example 1](#) except the readPoint of the *Shipping* event in the transaction history is set to the 3PL's sGLN.

Reference File: <https://resources.gs1us.org/Portals/0/xml/LotChoreo-3PL Example-W1toD.xml>

```

<?xml version="1.0" encoding="UTF-8" standalone="yes"?>
<!-- Lot Choreography End to End Examples: 3PL - EXAMPLE 1: W1->D -->
<epcis:EPCISDocument xmlns:cbvmda="urn:epcglobal:cbv:mda"
xmlns:sbdh="http://www.unece.org/cefact/namespaces/StandardBusinessDocumentHeader"
xmlns:gslushc="http://epcis.gs1us.org/hc/ns" xmlns:epcis="urn:epcglobal:epcis:xsd:1"
schemaVersion="1.2" xsi:schemaLocation="urn:epcglobal:epcis:xsd:1 EPCglobal-epcis-1_2.xsd"
xmlns:xsi="http://www.w3.org/2001/XMLSchema-instance" creationDate="2014-05-30T15:14:27.574-
04:00">
  <EPCISHeader>
    <sbdh:StandardBusinessDocumentHeader>
      <sbdh:HeaderVersion>1.0</sbdh:HeaderVersion>
      <sbdh:Sender>
        <sbdh:Identifier
Authority="SGLN">urn:epc:id:sgln:0614141.00000.0</sbdh:Identifier>
      </sbdh:Sender>
      <sbdh:Receiver>
        <sbdh:Identifier
Authority="SGLN">urn:epc:id:sgln:5012345.00000.0</sbdh:Identifier>
      </sbdh:Receiver>
      <sbdh:DocumentIdentification>
        <sbdh:Standard>EPCglobal</sbdh:Standard>
        <sbdh:TypeVersion>1.0</sbdh:TypeVersion>
        <sbdh:InstanceIdentifier>1234567890</sbdh:InstanceIdentifier>

```

```

        <sbdh:Type>Events</sbdh:Type>
        <sbdh:CreationDateAndTime>2014-05-30T15:14:27.574-04:00</sbdh:CreationDateAndTime>
    </sbdh:DocumentIdentification>
</sbdh:StandardBusinessDocumentHeader>
<extension>
    <EPCISMasterData>
        <VocabularyList>
            <Vocabulary type="urn:epcglobal:epcis:vtype:EPCClass">
                <VocabularyElementList>
                    <VocabularyElement id="urn:epc:idpat:sgtin:030000.0000001.*">
                        <attribute
id="urn:epcglobal:cbv:mda#additionalTradeItemIdentification">00000000001</attribute>
                        <attribute
id="urn:epcglobal:cbv:mda#additionalTradeItemIdentificationTypeCode">FDA_NDC_11</attribute>
                        <attribute
id="urn:epcglobal:cbv:mda#regulatedProductName">Epcistra</attribute>
                        <attribute
id="urn:epcglobal:cbv:mda#manufacturerOfTradeItemPartyName">GS1 Pharma LLC</attribute>
                        <attribute id="urn:epcglobal:cbv:mda#dosageFormType">PILL</attribute>
                        <attribute
id="urn:epcglobal:cbv:mda#strengthDescription">100mg</attribute>
                        <attribute id="urn:epcglobal:cbv:mda#netContentDescription">500
pills</attribute>
                    </VocabularyElement>
                </VocabularyElementList>
            </Vocabulary>
            <Vocabulary type="urn:epcglobal:epcis:vtype:Location">
                <VocabularyElementList>
                    <VocabularyElement id="urn:epc:id:sgln:030000.000000.0">
                        <attribute id="urn:epcglobal:cbv:mda#name">GS1 Pharma LLC</attribute>
                        <attribute id="urn:epcglobal:cbv:mda#streetAddressOne">1295 S George
Ave</attribute>
                        <attribute id="urn:epcglobal:cbv:mda#streetAddressTwo">Room
378</attribute>
                        <attribute id="urn:epcglobal:cbv:mda#city">Washington</attribute>
                        <attribute id="urn:epcglobal:cbv:mda#state">DC</attribute>
                        <attribute id="urn:epcglobal:cbv:mda#postalCode">12345-
6789</attribute>
                        <attribute id="urn:epcglobal:cbv:mda#countryCode">US</attribute>
                    </VocabularyElement>
                    <VocabularyElement id="urn:epc:id:sgln:0724142.00001.0">
                        <attribute id="urn:epcglobal:cbv:mda#name">GS1 3PL LLC</attribute>
                        <attribute id="urn:epcglobal:cbv:mda#streetAddressOne">230 Madison
Ave S</attribute>
                        <attribute id="urn:epcglobal:cbv:mda#city">New York</attribute>
                        <attribute id="urn:epcglobal:cbv:mda#state">NY</attribute>
                        <attribute id="urn:epcglobal:cbv:mda#postalCode">10003-
1502</attribute>
                        <attribute id="urn:epcglobal:cbv:mda#countryCode">US</attribute>
                    </VocabularyElement>
                    <VocabularyElement id="urn:epc:id:sgln:0614141.00000.0">
                        <attribute id="urn:epcglobal:cbv:mda#name">GS1 Drug Distro
LLC</attribute>
                        <attribute id="urn:epcglobal:cbv:mda#streetAddressOne">230 Park Ave
S</attribute>
                        <attribute id="urn:epcglobal:cbv:mda#city">New York</attribute>
                        <attribute id="urn:epcglobal:cbv:mda#state">NY</attribute>
                        <attribute id="urn:epcglobal:cbv:mda#postalCode">10003-
1502</attribute>
                        <attribute id="urn:epcglobal:cbv:mda#countryCode">US</attribute>
                    </VocabularyElement>
                </VocabularyElementList>
            </Vocabulary>
        </VocabularyList>
    </EPCISMasterData>
</extension>

```

```

        <VocabularyElement id="urn:epc:id:sgln:5012345.00000.0">
          <attribute id="urn:epcglobal:cbv:mda#name">GS1 Pere et Fils
Pharmacy</attribute>
          <attribute id="urn:epcglobal:cbv:mda#streetAddressOne">1313
Mockingbird Lane</attribute>
          <attribute id="urn:epcglobal:cbv:mda#city">Paris</attribute>
          <attribute id="urn:epcglobal:cbv:mda#state">TX</attribute>
          <attribute id="urn:epcglobal:cbv:mda#postalCode">76543</attribute>
          <attribute id="urn:epcglobal:cbv:mda#countryCode">US</attribute>
        </VocabularyElement>
      </VocabularyElementList>
    </Vocabulary>
  </VocabularyList>
</EPCISMasterData>
</extension>
<gslushc:dscsaTransactionStatement>
  <gslushc:affirmTransactionStatement>true</gslushc:affirmTransactionStatement>
  <gslushc:legalNotice>Seller has complied with each applicable subsection of FDCA Sec.
581 (27) (A)-(G). As indicated below, product was purchased directly from the manufacturer,
manufacturer's exclusive distributor or repackager who purchased directly from a
manufacturer.</gslushc:legalNotice>
</gslushc:dscsaTransactionStatement>
</EPCISHeader>
<EPCISBody>
  <EventList>
    <!-- Transaction History (TH) -->
    <ObjectEvent>
      <eventTime>1970-01-01T00:00:00.000Z</eventTime>
      <eventTimeZoneOffset>+00:00</eventTimeZoneOffset>
      <epcList/>
      <action>OBSERVE</action>
      <bizStep>urn:epcglobal:cbv:bizstep:shipping</bizStep>
      <disposition>urn:epcglobal:cbv:disp:in_transit</disposition>
      <readPoint>
        <id>urn:epc:id:sgln:0724142.00001.0</id>
      </readPoint>
      <extension>
        <quantityList>
          <quantityElement>
            <epcClass>urn:epc:idpat:sgtin:030000.0000001.*</epcClass>
            <quantity>50</quantity>
          </quantityElement>
        </quantityList>
        <sourceList>
          <source
type="urn:epcglobal:cbv:sdt:owning_party">urn:epc:id:sgln:030000.000000.0</source>
          </sourceList>
        <destinationList>
          <destination
type="urn:epcglobal:cbv:sdt:owning_party">urn:epc:id:sgln:0614141.00000.0</destination>
          </destinationList>
        </extension>
      </ObjectEvent>
    <!-- Transaction Information (TI) -->
    <ObjectEvent>
      <eventTime>2014-04-05T11:00:00.000-04:00</eventTime>
      <eventTimeZoneOffset>-04:00</eventTimeZoneOffset>
      <epcList/>
      <action>OBSERVE</action>
      <bizStep>urn:epcglobal:cbv:bizstep:shipping</bizStep>
      <disposition>urn:epcglobal:cbv:disp:in_transit</disposition>

```

```
<readPoint>
  <id>urn:epc:id:sgln:0614141.00000.0</id>
</readPoint>
<extension>
  <quantityList>
    <quantityElement>
      <epcClass>urn:epc:idpat:sgtin:030000.0000001.*</epcClass>
      <quantity>50</quantity>
    </quantityElement>
  </quantityList>
  <sourceList>
    <source
type="urn:epcglobal:cbv:sdt:owning_party">urn:epc:id:sgln:0614141.00000.0</source>
    </sourceList>
    <destinationList>
      <destination
type="urn:epcglobal:cbv:sdt:owning_party">urn:epc:id:sgln:5012345.00000.0</destination>
      </destinationList>
    </extension>
    <gslushc:directPurchase value="true"/>
  </ObjectEvent>
</EventList>
</EPCISBody>
</epcis:EPCISDocument>
```

Proprietary Statement

This document contains proprietary information of GS1 US. Such proprietary information may not be changed for use with any other parties for any other purpose without the expressed written permission of GS1 US.

Improvements

Improvement and changes are periodically made to publications by GS1 US. All material is subject to change without notice. Please refer to GS1 US website for the most current publication available. Although GS1 publications may, where appropriate, consider or address applicable statutory and regulatory requirements, such requirements are subject to change by implementing government agencies, and GS1 cannot guarantee that its publications will reflect all current statutory and regulatory requirements.

Disclaimer

Except as may be otherwise indicated in specific documents within this publication, you are authorized to view documents within this publication, subject to the following:

1. You agree to retain all copyright and other proprietary notices on every copy you make.
2. Some documents may contain other proprietary notices and copyright information relating to that document. You agree that GS1 US has not conferred by implication, estoppels or otherwise any license or right under any patent, trademark or copyright (except as expressly provided above) of GS1 US or of any third party.

THIS PUBLICATION IS PROVIDED "AS IS" WITHOUT WARRANTY OF ANY KIND, EITHER EXPRESS OR IMPLIED, INCLUDING, BUT NOT LIMITED TO, THE IMPLIED WARRANTIES OF MERCHANTABILITY, FITNESS FOR A PARTICULAR PURPOSE, OR NON-INFRINGEMENT. You are solely responsible for determining the appropriateness of using this publication and assume any risks associated with your use thereof, and GS1 US does not represent or warrant that the guidelines in this publication are appropriate for your particular company or your particular applications, products or processes. Any GS1 US publication may include technical inaccuracies or typographical errors. GS1 US assumes no responsibility for and disclaims all liability for any errors or omissions in this publication or in other documents which are referred to within or linked to this publication. Some jurisdictions do not allow the exclusion of implied warranties, so the above exclusion may not apply to you.

Several products and company names mentioned herein may be trademarks and/or registered trademarks of their respective companies. GS1 US does not, by promulgating this document on behalf of the parties involved in the creation of this document, represent that any methods, products, and/or systems discussed or recommended in the document do not violate the intellectual property rights of any third party. GS1 US has not performed a search to determine what intellectual property may be infringed by an implementation of any strategies or suggestions included in this document. GS1 US hereby disclaims any liability for any party's infringement of intellectual property rights that arise as a result of any implementation of strategies or suggestions included in this document.

This publication may be distributed internationally and may contain references to GS1 US products, programs and services that have not been announced in your country. These references do not imply that GS1 US intends to announce such products, programs or services in your country.

Limitation of Liability; No Liability for Consequential Damage

In no event shall GS1 US or anyone else involved in the creation, production, or delivery of the accompanying documentation be liable for any direct, indirect, special, incidental, or consequential damages of any character whatsoever (including, without limitation, damages for loss of business profits, business interruption, loss of business information, loss of goodwill, work stoppage, or other loss of any kind) arising out of the use of or the results of use of or inability to use such documentation, even if GS1 US has been advised of the possibility of such damages.

IAPMO

In this publication, the letters "U.P.C." are used solely as an abbreviation for the "Universal Product Code" which is a product identification system. They do not refer to the UPC, which is a federally registered certification mark of the International Association of Plumbing and Mechanical Officials (IAPMO) to certify compliance with a Uniform Plumbing Code as authorized by IAPMO.

GS1 US Corporate Headquarters

Princeton Pike Corporate Center, 1009 Lenox Drive, Suite 202
Lawrenceville, NJ 08648 USA
T +1 937.435.3870 | **E** info@gs1us.org
www.gs1us.org

Connect With Us

